

Product: John Deere 924DE/1128DE/1128DDE/1332DDE Walk-Behind Snowblowers Service Repair Technical Manual
Full Download: <https://www.bobmanualstore.com/downloads/john-deere-924de-1128de-1128dde-1332dde-walk-behind-snowblowers-service-repair-technical-manual/>

924DE, 1128DE, 1128DDE, and 1332DDE Walk-Behind Snowblowers

TECHNICAL MANUAL

John Deere
Worldwide Commercial and
Consumer Equipment Division
TM1867 (12Jul00)

Sample manual. Download All 174 pages at:

<https://www.bobmanualstore.com/downloads/john-deere-924de-1128de-1128dde-1332dde-walk-behind-snowblowers-service-repair-technical-manual/>

Litho in U.S.A

Product: John Deere 924DE/1128DE/1128DDE/1332DDE Walk-Behind Snowblowers Service Repair Technical Manual
Full Download: <https://www.bobmanualstore.com/downloads/john-deere-924de-1128de-1128dde-1332dde-walk-behind-snowblowers-service-repair-technical-manual/>

Walk-Behind Snowblowers



Model 924DE



Model 1128DE



Model 1128DDE AND 1332DDE

Sample manual. Download All 174 pages at:

<https://www.bobmanualstore.com/downloads/john-deere-924de-1128de-1128dde-1332dde-walk-behind-snowblowers-service-repair-technical-manual/>

This technical manual is written for an experienced technician and contains sections that are specifically for this product. It is a part of a total product support program.

The manual is organized so that all the information on a particular system is kept together. The order of grouping is as follows:

- Table of Contents
- Specifications
- Component Location
- System Schematic
- Theory of Operation
- Troubleshooting Chart
- Diagnostics
- Tests & Adjustments
- Repair

Note: Depending on the particular section or system being covered, not all of the above groups may be used.

Each section will be identified with a symbol rather than a number. The groups and pages within a section will be consecutively numbered.

We appreciate your input on this manual. To help, there are postage paid post cards included at the back. If you find any errors or want to comment on the layout of the manual please fill out one of the cards and mail it back to us.

All information, illustrations and specifications in this manual are based on the latest information available at the time of publication. The right is reserved to make changes at any time without notice.

COPYRIGHT© 2000
Deere & Co.
John Deere Worldwide Commercial and
Consumer Equipment Division
Horicon, WI
All rights reserved

Safety



Specifications and Information



Engine



Electrical



Power Train



Miscellaneous





HANDLE FLUIDS SAFELY-AVOID FIRES

- **BE PREPARED FOR EMERGENCIES**

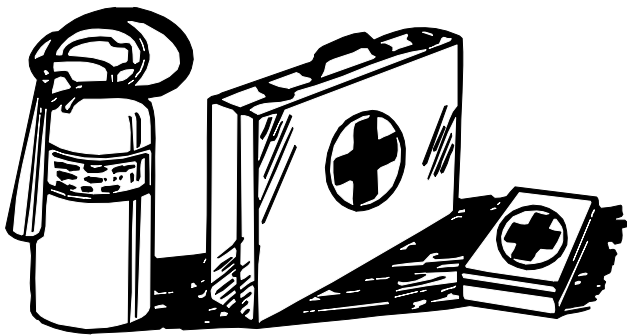

When you work around fuel, do not smoke or work near heaters or other fire hazards.

Store flammable fluids away from fire hazards. Do not incinerate or puncture pressurized containers.

Make sure machine is clean of trash, grease, and debris.

Do not store oily rags; they can ignite and burn spontaneously.

Be prepared if a fire starts.

Keep a first aid kit and fire extinguisher handy.

Keep emergency numbers for doctors, ambulance service, hospital, and fire department near your telephone.

HANDLE CHEMICAL PRODUCTS SAFELY

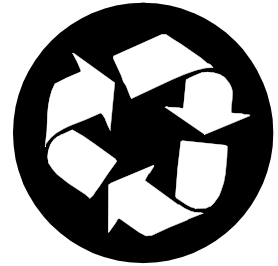
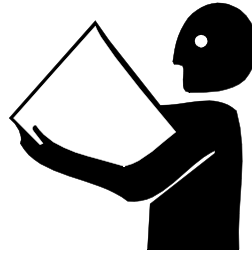

Direct exposure to hazardous chemicals can cause serious injury. Potentially hazardous chemicals used with John Deere equipment include such items as lubricants, coolants, paints, and adhesives.

A Material Safety Data Sheet (MSDS) provides specific details on chemical products: physical and health hazards, safety procedures, and emergency response techniques. Check the MSDS before you start any job using a hazardous chemical. That way you will know exactly what the risks are and how to do the job safely. Then follow procedures and recommended equipment.

- **DISPOSE OF WASTE PROPERLY**

Improperly disposing of waste can threaten the environment and ecology. Potentially harmful waste used with John Deere equipment include such items as oil, fuel, coolant, brake fluid, filters, and batteries. Use leakproof containers when draining fluids. Do not use food or beverage containers that may mislead someone into drinking from them. Do not pour waste onto the ground, down a drain, or into any water source. Inquire on the proper way to recycle or dispose of waste from your local environmental or recycling center, or from your John Deere dealer.

USE SAFE SERVICE PROCEDURES

• WEAR PROTECTIVE CLOTHING

Wear close fitting clothing and safety equipment appropriate to the job.

Prolonged exposure to loud noise can cause impairment or loss of hearing. Wear a suitable hearing protective device such as earmuffs or earplugs to protect against objectionable or uncomfortable loud noises.

Operating equipment safely requires the full attention of the operator. Do not wear radio or music headphones while operating machine.

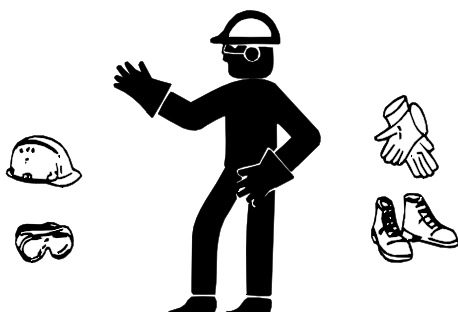

• SERVICE MACHINES SAFELY

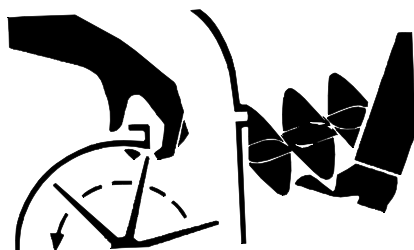

• USE PROPER TOOLS

Use tools appropriate to the work. Makeshift tools and procedures can create safety hazards. Use power tools only to loosen threaded parts and fasteners. For loosening and tightening hardware, use the correct size tools. **DO NOT** use U.S. measurement tools on metric fasteners. Avoid bodily injury caused by slipping wrenches. Use only service parts meeting John Deere specifications.

• PARK MACHINE SAFELY

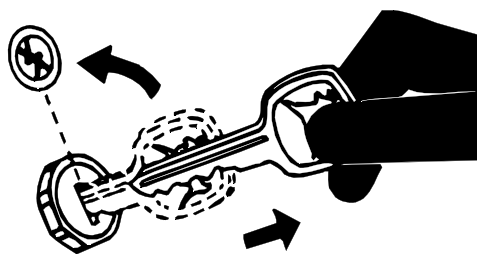

• Before working on the machine:

1. Lower all equipment to the ground.
2. Stop the engine and remove the key.
3. Disconnect the battery ground strap.
4. Hang a "DO NOT OPERATE" tag in operator station.

• SUPPORT MACHINE PROPERLY AND USE PROPER LIFTING EQUIPMENT

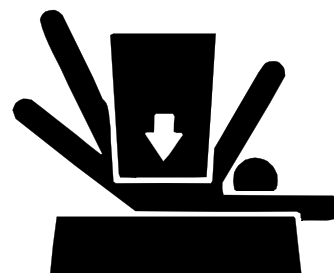

If you must work on a lifted machine or attachment, securely support the machine or attachment.

Do not support the machine on cinder blocks, hollow tiles, or props that may crumble under continuous load. Do not work under a machine that is supported solely by a jack. Follow recommended procedures in this manual.

Lifting heavy components incorrectly can cause severe injury or machine damage. Follow recommended procedure for removal and installation of components in the manual.

• WORK IN CLEAN AREA

• Before starting a job

1. Clean work area and machine.
2. Make sure you have all necessary tools to do your job.
3. Have the right parts on hand.
4. Read all instructions thoroughly; do not attempt shortcuts.





- **ILLUMINATE WORK AREA SAFELY**

Illuminate your work area adequately but safely. Use a portable safety light for working inside or under the machine. Make sure the bulb is enclosed by a wire cage. The hot filament of an accidentally broken bulb can ignite spilled fuel or oil.

- **WORK IN VENTILATED AREA**

WARNING: California Proposition 65

Warning

Diesel engine exhaust and some of its constituents are known to the State of California to cause cancer, birth defects, and other reproductive harm.

Gasoline engine exhaust from this product contains chemicals known to the State of California to cause cancer, birth defects, or other reproductive harm.

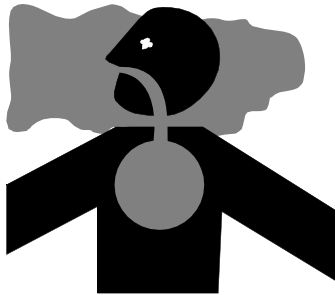

Engine exhaust fumes can cause sickness or death. If it is necessary to run an engine in an enclosed area, remove the exhaust fumes from the area with an exhaust pipe extension.

If you do not have an exhaust pipe extension, open the doors and get outside air into the area.

- **REMOVE PAINT BEFORE WELDING OR HEATING**

Avoid potentially toxic fumes and dust. Hazardous fumes can be generated when paint is heated by welding, soldering, or using a torch. Do all work outside or in a well ventilated area. Dispose of paint and solvent properly. Remove paint before welding or heating: If you sand or grind paint, avoid breathing the dust. Wear an approved respirator. If you use solvent or paint stripper, remove stripper with soap and water before welding. Remove solvent or paint stripper containers and other flammable material from area. Allow fumes to disperse at least 15 minutes before welding or heating.

- **AVOID HARMFUL ASBESTOS DUST**

Avoid breathing dust that may be generated when handling components containing asbestos fibers. Inhaled asbestos fibers may cause lung cancer.

Components in products that may contain asbestos fibers are brake pads, brake band and lining assemblies, clutch plates, and some gaskets. The asbestos used in these components is usually found in a resin or sealed in some way. Normal handling is not hazardous as long as airborne dust containing asbestos is not generated.

Avoid creating dust. Never use compressed air for cleaning. Avoid brushing or grinding material containing asbestos. When servicing, wear an approved respirator. A special vacuum cleaner is recommended to clean asbestos. If not available, apply a mist of oil or water on the material containing asbestos. Keep bystanders away from the area.

- **SERVICE TIRES SAFELY**

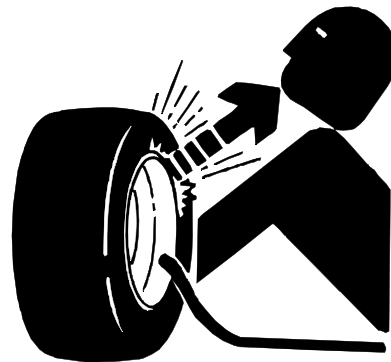

Explosive separation of a tire and rim parts can cause serious injury or death.

Do not attempt to mount a tire unless you have the proper equipment and experience to perform the job. Always maintain the correct tire pressure. Do not inflate the tires above the recommended pressure. Never weld or heat a wheel and tire assembly. The heat can cause an increase in air pressure resulting in a tire explosion. Welding can structurally weaken or deform the wheel.

When inflating tires, use a clip-on chuck and extension hose long enough to allow you to stand to one side and NOT in front of or over the tire assembly. Use a safety cage if available.

- **Check wheels for low pressure, cuts, bubbles, damaged rims or missing lug bolts and nuts.**

AVOID INJURY FROM ROTATING AUGERS

Keep hands and feet away from auger housing. Never try to work on auger or clear any material from auger housing while machine is running or spark plug is connected.

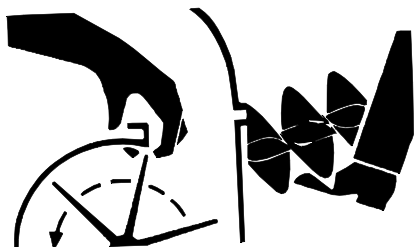

REPLACE SAFETY SIGNS

Replace missing or damaged safety signs. See the machine operator's manual for correct safety sign placement.



LIVE WITH SAFETY



Before returning machine to customer, make sure machine is functioning properly, especially the safety systems. Install all guards and shields.



CONTENTS

	Page
SPECIFICATIONS	3
ENGINE	3
FUEL	3
ELECTRICAL	3
AUGER	4
TIRES	4
OVERALL DIMENSIONS	4
FRICTION DRIVE SYSTEM	4
METRIC FASTENER TORQUE VALUES	5
INCH FASTENER TORQUE VALUES	6
GASOLINE	7
GASOLINE STORAGE	7
ENGINE OIL	8
ENGINE BREAK-IN OIL	8
ANTI-CORROSION GREASE	9
GEAR CASE OIL	9
ALTERNATIVE LUBRICANTS	9
SYNTHETIC LUBRICANTS	9
LUBRICANT STORAGE	10
MIXING OF LUBRICANTS	10
GREASE	10
PRODUCT IDENTIFICATION LOCATIONS	10





SPECIFICATIONS



	924DE	1128DE	1128DDE	1332DDE
ENGINE				
Manufacturer	Tecumseh -Snow King	Tecumseh -Snow King	Tecumseh -Snow King	Tecumseh -Snow King
Model	OHSK90	OHSK110	OHSK110	OHSK130
Type (cycle)	4 cycle	4 cycle	4 cycle	4 cycle
Horsepower	6.71 kW (9 hp)	8.20 kW (11 hp)	8.20 kW (11 hp)	9.69 kW (13 hp)
Slow Engine Idle speed	2000 ± 150 rpm	2000 ± 150 rpm	2000 ± 150 rpm	2000 ± 150 rpm
Fast Engine Idle speed	3600 ± 150 rpm	3600 ± 150 rpm	3600 ± 150 rpm	3600 ± 150 rpm
Displacement	318.46 cm ³ (19.43 cu. in.)	318.46 cm ³ (19.43 cu. in.)	318.46 cm ³ (19.43 cu. in.)	357.63 cm ³ (21.82 cu. in.) ³
Bore - Std.	79.375 mm (3.125 in.)	79.375 mm (3.125 in.)	79.375 mm (3.125 in.)	84.125 mm (3.312 in.)
Bore - Max.	79.400 mm (3.126 in.)	79.400 mm (3.126 in.)	79.400 mm (3.126 in.)	84.150 mm (3.313 in.)
Stroke	70.993 mm (2.532 in.)	70.993 mm (2.532 in.)	70.993 mm (2.532 in.)	70.993 mm (2.532 in.)
Lubrication Type	Oil Dipper	Oil Dipper	Oil Dipper	Counterbalance Shaft
Oil capacity	0.77 L (26 U.S. oz.)	0.77 L (26 U.S. oz.)	0.77 L (26 U.S. oz.)	0.95 L (32 U.S. oz.)
Oil fill	Tube/dipstick in front of engine	Tube/dipstick in front of engine	Tube/dipstick in front of engine	Tube/dipstick in front of engine
FUEL				
Type required	Unleaded gasoline - 87 octane or higher	Unleaded gasoline - 87 octane or higher	Unleaded gasoline - 87 octane or higher	Unleaded gasoline - 87 octane or higher
Fuel tank	3.8 L (1.0 U.S. gal.)	3.8 L (1.0 U.S. gal.)	3.8 L (1.0 U.S. gal.)	3.8 L (1.0 U.S. gal.)
Fuel filter	Fine mesh in fuel tank Fine paper in-line between shut-off & carburetor (optional)	Fine mesh in fuel tank Fine paper in-line between shut-off & carburetor (optional)	Fine mesh in fuel tank Fine paper in-line between shut-off & carburetor (optional)	Fine mesh in fuel tank Fine paper in-line between shut-off & carburetor (optional)
ELECTRICAL				
Ignition	Electronic Capacitor Discharge Ignition (CDI) System	Electronic Capacitor Discharge Ignition (CDI) System	Electronic Capacitor Discharge Ignition (CDI) System	Electronic Capacitor Discharge Ignition (CDI) System

Spark plug	RN4C	RN4C	RN4C	RN4C
Spark plug gap	0.762 mm (0.030 in.)	0.762 mm (0.030 in.)	0.762 mm (0.030 in.)	0.762 mm (0.030 in.)
Electric start	Standard; 120 V Electric Start Kit	Standard; 120 V Electric Start Kit	Standard; 120 V Electric Start Kit	Standard; 120 V Electric Start Kit
Starting	Standard Recoil Pull Start with Automatic Compression Release (ACR)	Standard Recoil Pull Start with Automatic Compression Release (ACR)	Standard Recoil Pull Start with Automatic Compression Release (ACR)	Standard Recoil Pull Start with Automatic Compression Release (ACR)
Alternator	18 Watt	18 Watt	3 and 5 Amp	3 and 5 Amp
Headlight	Standard	Standard	Standard	Standard

AUGER

Type	2 - Stage Serrated Steel	2 - Stage Serrated Steel	2 - Stage Serrated Steel	2 - Stage Serrated Steel
Clearing width	610 mm (24 in.)	711 mm (28 in.)	711 mm (28 in.)	813 mm (32 in.)
Housing opening (height)	406 mm (16 in.)	406 mm (16 in.)	584 mm (23 in.)	584 mm (23 in.)
Shaft Dia.	19 mm (0.75 in.)	19 mm (0.75 in.)	25.4 mm (1.0 in.)	25.4 mm (1.0 in.)
Discharge chute rotation	220 degrees	220 degrees	220 degrees	220 degrees
Blower Dia.	305 mm (12 in.)	305 mm (12 in.)	305 mm (12 in.)	305 mm (12 in.)

TIRES

Wheels	Steel	Steel	Steel	Steel
Tires	Pneumatic - Snow Hog	Pneumatic - Snow Hog	Pneumatic - Snow Hog	Pneumatic - Snow Hog
Tire size	4.80 - 8	4.80 - 8	4.80 - 8	16 x 6.50 - 8















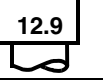

OVERALL DIMENSIONS

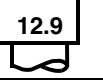
Length	1524 mm (60 in.)	1524 mm (60 in.)	1524 mm (60 in.)	1524 mm (60 in.)
Width	673 mm (26.5 in.)	775 mm (30.5 in.)	775 mm (30.5 in.)	876 mm (34.5 in.)
Height	1016 mm (40.0 in.)	1016 mm (40.0 in.)	1016 mm (40.0 in.)	1016 mm (40.0 in.)
Net weight	113 kg (250 lb.)	119 kg (263 lb.)	128 kg (283 lb.)	131 kg (288 lb.)

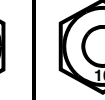
FRICITION DRIVE SYSTEM

Drive components: Primary reduction—V-belt from engine to transmission.
 Transmission—spring loaded friction disc driven from aluminum input disk.
 Gear reduction to axle shaft.

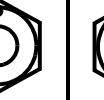
METRIC FASTENER TORQUE VALUES

Property Class and Head Markings	4.8		8.8		9.8		10.9		12.9	
										
Property Class and Nut Markings	5		10		10		10		12	
										

TS1163

SIZE	Class 4.8				Class 8.8 or 9.8				Class 10.9				Class 12.9			
	Lubricated ^a		Dry ^a		Lubricated ^a		Dry ^a		Lubricated ^a		Dry ^a		Lubricated ^a		Dry ^a	
	N•m	lb-ft	N•m	lb-ft	N•m	lb-ft	N•m	lb-ft	N•m	lb-ft	N•m	lb-ft	N•m	lb-ft	N•m	lb-ft
M6	48	3.5	6	4.5	9	6.5	11	8.5	13	9.5	17	12	15	11.5	19	14.5
M8	12	8.5	15	11	22	16	28	20	32	24	40	30	37	28	47	35
M10	23	17	29	21	43	32	55	40	63	47	80	60	75	55	95	70
M12	40	29	50	37	75	55	95	70	110	80	140	105	130	95	165	120
M14	63	47	80	60	120	88	150	110	175	130	225	165	205	150	260	109
M16	100	73	125	92	190	140	240	175	275	200	350	225	320	240	400	300
M18	135	100	175	125	260	195	330	250	375	275	475	350	440	325	560	410
M20	190	140	240	180	375	275	475	350	530	400	675	500	625	460	800	580
M22	260	190	330	250	510	375	650	475	725	540	925	675	850	625	1075	800
M24	330	250	425	310	650	475	825	600	925	675	1150	850	1075	800	1350	1000
M27	490	360	625	450	950	700	1200	875	1350	1000	1700	1250	1600	1150	2000	1500
M30	675	490	850	625	1300	950	1650	1200	1850	1350	2300	1700	2150	1600	2700	2000
M33	900	675	1150	850	1750	1300	2200	1650	2500	1850	3150	2350	2900	2150	3700	2750
M36	1150	850	1450	1075	2250	1650	2850	2100	3200	2350	4050	3000	3750	2750	4750	3500

DO NOT use these hand torque values if a different torque value or tightening procedure is given for a specific application. Torque values listed are for general use only and include a ±10% variance factor. Check tightness of fasteners periodically. DO NOT use air powered wrenches.

Shear bolts are designed to fail under predetermined loads. Always replace shear bolts with identical grade.

Fasteners should be replaced with the same grade. Make sure fastener threads are clean and that you properly start thread engagement. This will prevent them from failing when tightening.









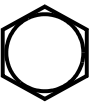

When bolt and nut combination fasteners are used, torque values should be applied to the **NUT** instead of the bolt head.

Tighten toothed or serrated-type lock nuts to the full torque value.

^a "Lubricated" means coated with a lubricant such as engine oil, or fasteners with phosphate and oil coatings. "Dry" means plain or zinc plated (yellow dichromate - Specification JDS117) without any lubrication.
Reference: JDS—G200.

INCH FASTENER TORQUE VALUES



SAE Grade and Head Markings	1 or 2 ^b No Marks 	5  5.1  5.2 	8  8.2 
	2 No Marks 	5  	8  

TS1162

SIZE	Grade 1				Grade 2 ^b				Grade 5, 5.1 or 5.2				Grade 8 or 8.2			
	Lubricated ^a		Dry ^a		Lubricated ^a		Dry ^a		Lubricated ^a		Dry ^a		Lubricated ^a		Dry ^a	
	N•m	lb-ft	N•m	lb-ft	N•m	lb-ft	N•m	lb-ft	N•m	lb-ft	N•m	lb-ft	N•m	lb-ft	N•m	lb-ft
1/4	3.7	2.8	4.7	3.5	6	4.5	7.5	5.5	9.5	7	12	9	13.5	10	17	12.5
5/16	7.7	5.5	10	7	12	9	15	11	20	15	25	18	28	21	35	26
3/8	14	10	17	13	22	16	27	20	35	26	44	33	50	36	63	46
7/16	22	16	28	20	35	26	44	32	55	41	70	52	80	58	100	75
1/2	33	25	42	31	53	39	67	50	85	63	110	80	120	90	150	115
9/16	48	36	60	45	75	56	95	70	125	90	155	115	175	130	225	160
5/8	67	50	85	62	105	78	135	100	170	125	215	160	215	160	300	225
3/4	120	87	150	110	190	140	240	175	300	225	375	280	425	310	550	400
7/8	190	140	240	175	190	140	240	175	490	360	625	450	700	500	875	650
1	290	210	360	270	290	210	360	270	725	540	925	675	1050	750	1300	975
1-1/8	470	300	510	375	470	300	510	375	900	675	1150	850	1450	1075	1850	1350
1-1/4	570	425	725	530	570	425	725	530	1300	950	1650	1200	2050	1500	2600	1950
1-3/8	750	550	950	700	750	550	950	700	1700	1250	2150	1550	2700	2000	3400	2550
1-1/2	1000	725	1250	925	990	725	1250	930	2250	1650	2850	2100	3600	2650	4550	3350

DO NOT use these hand torque values if a different torque value or tightening procedure is given for a specific application. Torque values listed are for general use only and include a ±10% variance factor. Check tightness of fasteners periodically. DO NOT use air powered wrenches.

Shear bolts are designed to fail under predetermined loads. Always replace shear bolts with identical grade.

Fasteners should be replaced with the same grade. Make sure fastener threads are clean and that you properly start thread engagement. This will prevent them from failing when tightening.

When bolt and nut combination fasteners are used, torque values should be applied to the **NUT** instead of the bolt head.

Tighten toothed or serrated-type lock nuts to the full torque value.

^a "Lubricated" means coated with a lubricant such as engine oil, or fasteners with phosphate and oil coatings. "Dry" means plain or zinc plated (yellow dichromate - Specification JDS117) without any lubrication.

^b "Grade 2" applies for hex cap screws (not hex bolts) up to 152 mm (6-in.) long. "Grade 1" applies for hex cap screws over 152 mm (6-in.) long, and for all other types of bolts and screws of any length.

Reference: JDS—G200.

GASOLINE

CAUTION

Gasoline is **HIGHLY FLAMMABLE**, handle it with care.

DO NOT refuel machine while:

- indoors, always fill gas tank outdoors;
- machine is near an open flame or sparks;
- engine is running, **STOP** engine;
- engine is hot, allow it to cool sufficiently first;
- smoking.

Help prevent fires:

- fill gas tank to bottom of filler neck only;
- be sure fill cap is tight after fueling;
- clean up any gas spills **IMMEDIATELY**;
- keep machine clean and in good repair—free of excess grease, oil, debris, and faulty or damaged parts;
- any storage of machines with gas left in tank should be in an area that is well ventilated to prevent possible igniting of fumes by an open flame or spark, this includes any appliance with a pilot light.

To prevent fire or explosion caused by STATIC ELECTRIC DISCHARGE during fueling:

- **ONLY** use a clean, approved **POLYETHYLENE PLASTIC** fuel container and funnel **WITHOUT** any metal screen or filter.

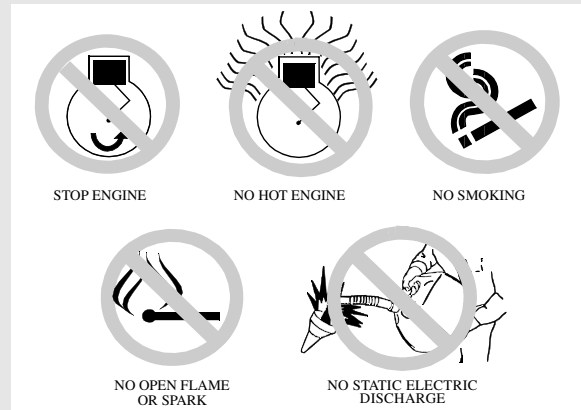

To avoid engine damage:

- DO NOT mix oil with gasoline;
- **ONLY** use clean, fresh unleaded gasoline with an octane rating (anti-knock index) of 87 or higher;
- fill gas tank at the end of each day's operation to help prevent condensation from forming inside a partially filled tank;
- keep up with specified service intervals.

Use of alternative oxygenated, gasohol blended, unleaded gasoline is acceptable as long as:

- the ethyl or grain alcohol blends DO NOT exceed 10% by volume or
- methyl tertiary butyl ether (MTBE) blends DO NOT exceed 15% by volume.

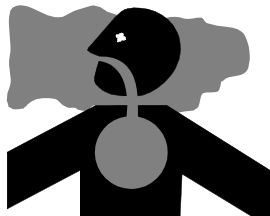

IMPORTANT: DO NOT use **METHANOL** gasoline because **METHANOL** is harmful to the environment and to your health.

WARNING

California Proposition 65 Warning: Gasoline engine exhaust from this product contains chemicals known to the State of California to cause cancer, birth defects, or other reproductive harm.

GASOLINE STORAGE

IMPORTANT: Keep all dirt, scale, water or other foreign material out of gasoline.

Keep gasoline stored in a safe, protected area. Storage of gasoline in a clean, properly marked ("**UNLEADED GASOLINE**") **POLYETHYLENE PLASTIC** container **WITHOUT** any metal screen or filter is recommended. **DO NOT** use de-icers to attempt to remove water from gasoline or depend on fuel filters to remove water from gasoline. Use a water separator installed in the storage tank outlet. **BE SURE** to properly discard unstable or contaminated gasoline. When storing unit or gasoline, it is recommended that you add **John Deere Gasoline Conditioner and Stabilizer (TY15977)** or an equivalent to the gasoline. **BE SURE** to follow directions on container and to properly discard empty container.

ENGINE OIL

Use the appropriate oil viscosity based on the expected air temperature range during the period between recommended oil changes. Operating outside of these recommended oil air temperature ranges may cause premature engine failure.



The following John Deere oil is **PREFERRED**:

- **TORQ-GARD SUPREME®—SAE 5W-30**
- **UNI-GARD™—SAE 5W-30**

The following John Deere oils are **also recommended**, based on their specified temperature range:

- **TURF-GARD®—SAE 10W-30**
- **PLUS-4®—SAE 10W-30**
- **UNI-GARD™—SAE 10W-30**
- **TORQ-GARD SUPREME®—SAE 30**
- **UNI-GARD™—SAE 30**

Other oils may be used if above John Deere oils are not available, provided they meet one of the following specifications:

- SAE 5W-30—API Service Classification SG or higher
- SAE 10W-30—API Service Classification SG or higher
- SAE 30—API Service Classification SC or higher
- CCMC Specification G4 or higher.

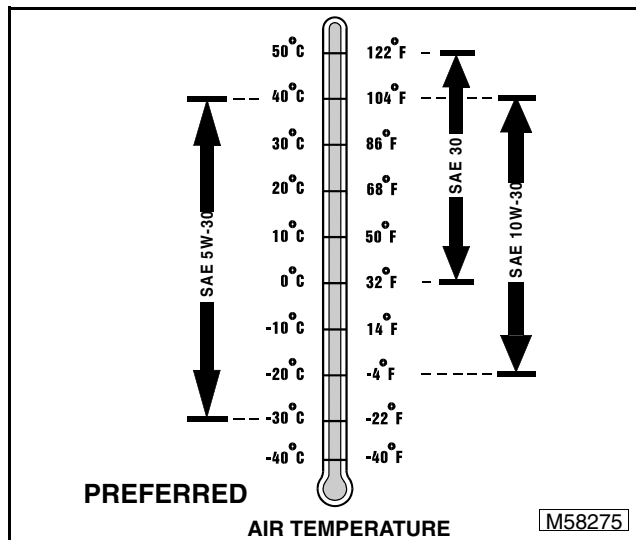

ENGINE BREAK-IN OIL

IMPORTANT: ONLY use a quality break-in oil in rebuilt or remanufactured engines for the first 5 hours (maximum) of operation. DO NOT use oils with heavier viscosity weights than SAE 5W-30 or oils meeting specifications API SG or SH, these oils will not allow rebuilt or remanufactured engines to break-in properly.

The following John Deere oil is **PREFERRED**:

- **BREAK-IN ENGINE OIL.**

John Deere BREAK-IN ENGINE OIL is formulated with special additives for aluminum and cast iron type engines to allow the power cylinder components (pistons, rings, and liners as well) to “wear-in” while protecting other engine components, valve train and gears, from abnormal wear. Engine rebuild instructions should be followed closely to determine if special requirements are necessary.

John Deere BREAK-IN ENGINE OIL is also recommended for non-John Deere engines, both aluminum and cast iron types.

The following John Deere oil is **also recommended** as a break-in engine oil:

- **TORQ-GARD SUPREME®—SAE 5W-30.**

If the above recommended John Deere oils are not available, use a break-in engine oil meeting the following specification during the first 5 hours (maximum) of operation:

- SAE 5W-30—API Service Classification SE or higher.
- SAE 5W-30—CCMC Specification G4 or higher.

IMPORTANT: After the break-in period, use the John Deere oil that is recommended for this engine.

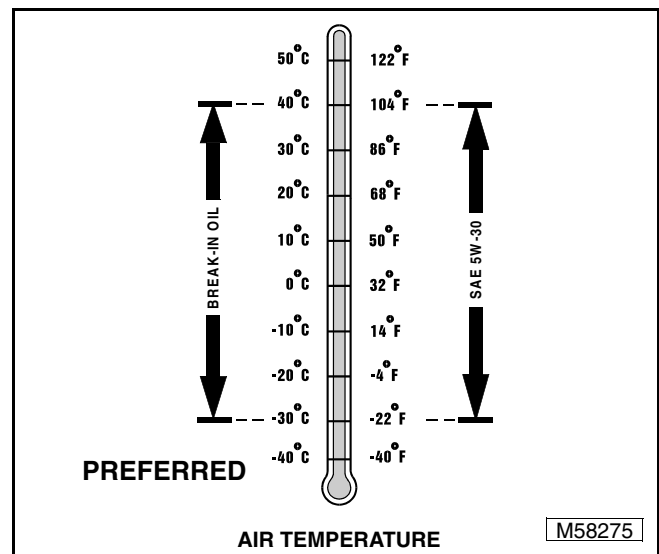

ANTI-CORROSION GREASE

This anti-corrosion grease is formulated to provide the best protection against absorbing moisture, which is one of the major causes of corrosion. This grease is also superior in its resistance to separation and migration.

The following anti-corrosion grease is **PREFERRED**:

- **DuBois MPG-2® Multi-Purpose Polymer Grease—M79292.**

Other greases may be used if they meet or exceed the following specifications:

- John Deere Standard JDM J13A2, NLGI Grade 1.

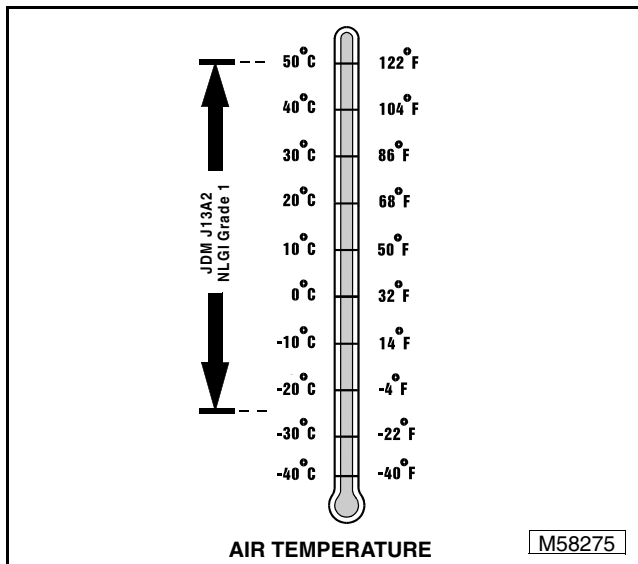

GEAR CASE OIL

Use the following oil viscosity based on the air temperature range. Operating outside of the recommended oil air temperature range may cause premature gear case failure.

IMPORTANT: ONLY use a quality oil in this gear case. DO NOT mix any other oils in this gear case. DO NOT use BIO-HY-GARD® in this gear case.

The following John Deere gear case oil is **PREFERRED**:

- **GL-5 GEAR LUBRICANT®—SAE 80W-90.**
- **EXTREME-GARD™—SAE 80W-90.**

Other gear case oils may be used if above recommended John Deere gear case oil is not available, provided they meet the following specification:

- API Service Classification GL-5.

John Deere Dealers: You may want to cross-reference

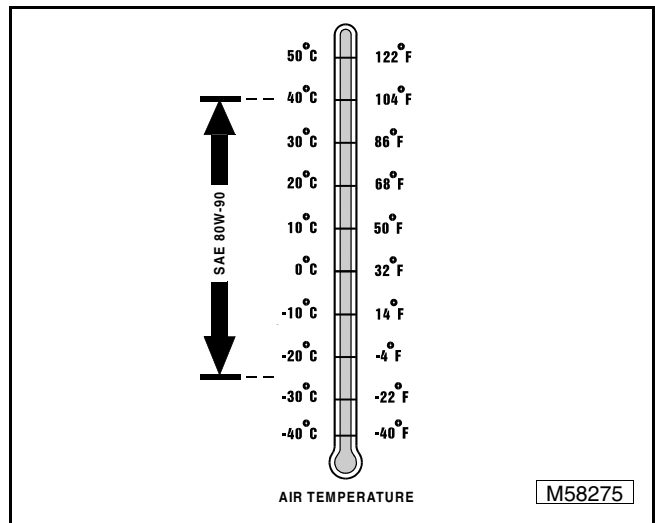

the following publications to recommend the proper oil for your customers:

- Module DX, GEOIL in JDS-G135;
- Section 530, Lubricants & Hydraulics, of the John Deere Merchandise Sales Guide;
- Lubrication Sales Manual PI7032.

ALTERNATIVE LUBRICANTS

Conditions in certain geographical areas outside the United States and Canada may require different lubricant recommendations than the ones printed in this technical manual or the operator's manual. Consult with your John Deere Dealer, or Sales Branch, to obtain the alternative lubricant recommendations.

IMPORTANT: Use of alternative lubricants could cause reduced life of the component.

If alternative lubricants are to be used, it is recommended that the factory fill be thoroughly removed before switching to any alternative lubricant.

SYNTHETIC LUBRICANTS

Synthetic lubricants may be used in John Deere equipment if they meet the applicable performance requirements (industry classification and/or military specification) as shown in this manual.

The recommended air temperature limits and service or lubricant change intervals should be maintained as shown in the operator's manual.

Avoid mixing different brands, grades, or types of oil. Oil manufacturers blend additives in their oils to meet certain specifications and performance requirements. Mixing different oils can interfere with the proper functioning of these additives and degrade lubricant performance.

LUBRICANT STORAGE

All machines operate at top efficiency only when clean lubricants are used. Use clean storage containers to handle all lubricants. Store them in an area protected from dust, moisture, and other contamination. Store drums on their sides. Make sure all containers are properly marked as to their contents. Dispose of all old, used containers and their contents properly.

MIXING OF LUBRICANTS

In general, avoid mixing different brands or types of lubricants. Manufacturers blend additives in their lubricants to meet certain specifications and performance requirements. Mixing different lubricants can interfere with the proper functioning of these additives and lubricant properties which will downgrade their intended specified performance.

GREASE

Use the following grease based on the air temperature range. Operating outside of the recommended grease air temperature range may cause premature failures.

The following should also be used in the auger.

IMPORTANT: ONLY use a quality grease in this application. DO NOT mix any other greases in this application. DO NOT use any BIO-GREASE in this application.

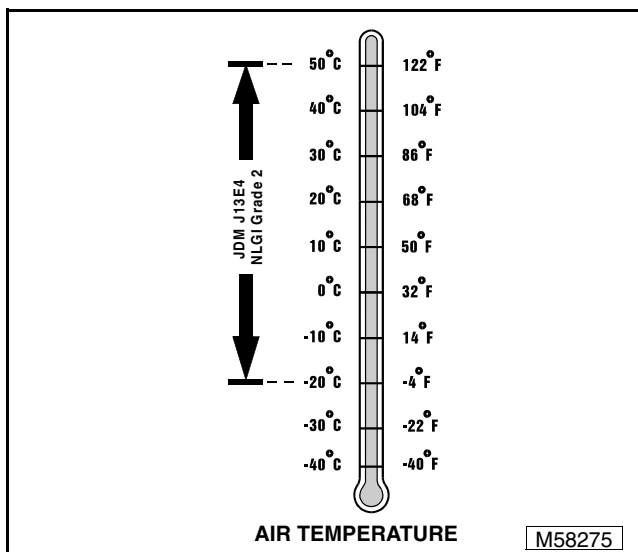

The following John Deere grease is **PREFERRED**:

- **NON-CLAY HIGH-TEMPERATURE EP GREASE®—JDM J13E4, NLGI Grade 2**
- **GREASE-GARD™—JDM J13E4, NLGI Grade 2**

Other greases may be used if above preferred John Deere grease is not available, provided they meet the following specification:

- John Deere Standard JDM J13E4, NLGI Grade 2

PRODUCT IDENTIFICATION LOCATIONS

When ordering parts or submitting a warranty claim, it is **IMPORTANT** that you include the product identification number (A) and the component product identification numbers (B).

The location of identification numbers and component product identification numbers are shown.

PRODUCT IDENTIFICATION NUMBER

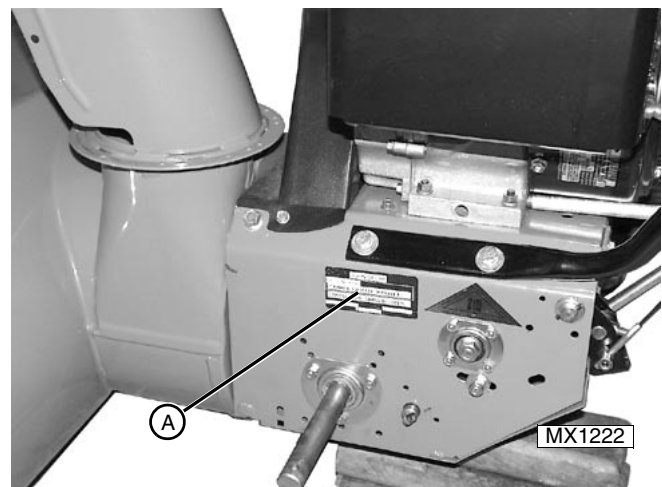

(1128DE Model shown; others similar)
(wheel removed for clarity)

ENGINE PIN NUMBER

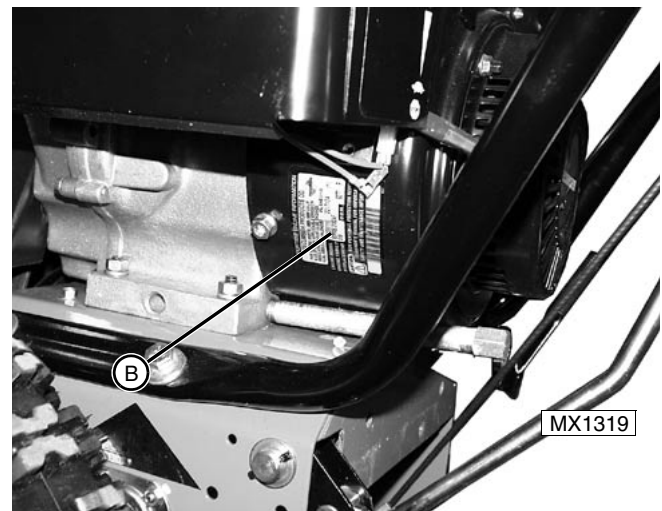

CONTENTS

Page

SPECIFICATIONS	3
ENGINE	3
FUEL	3
ELECTRICAL SPECIFICATIONS	4
REPAIR SPECIFICATIONS	4
TORQUE SPECIFICATIONS	5
OTHER MATERIALS	7
SPECIAL TOOLS	7
TROUBLESHOOTING	8
ENGINE TROUBLESHOOTING CHARTS	8
DIAGNOSTICS	11
ENGINE WILL NOT CRANK (RECOIL STARTER)	11
ENGINE TURNS OVER BUT WILL NOT START	12
ENGINE STOPS WHEN HOT	13
ENGINE BACKFIRES THROUGH CARBURETOR	14
BLUE EXHAUST SMOKE OR OIL IN CARBURETOR HOUSING	15
ENGINE MISS FIRES	16
ENGINE USES TOO MUCH OIL	17
LACK OF FUEL IN CARBURETOR	18
ENGINE FLOODED	19
BACKFIRES THROUGH MUFFLER WHEN SHUT-OFF	20
LOSES POWER OR RUNS ROUGH WHEN HOT	21
ENGINE SURGES	22
BLACK EXHAUST SMOKE	23
TESTS AND ADJUSTMENTS	24
SPARK PLUG AIR GAP ADJUSTMENT	24
IGNITION MODULE SPARK TEST	24
CRANKCASE VACUUM TESTS	25
GOVERNOR ADJUSTMENT (STATIC)	26
FAST IDLE SPEED ADJUSTMENT	27
GOVERNED IDLE SPEED SCREW ADJUSTMENT—1332DDE	28
SLOW IDLE STOP SCREW ADJUSTMENT	28
CRANKCASE BREATHER ASSEMBLY TEST	29
VALVE-TO-ROCKER ARM CLEARANCE TEST	30
AUTOMATIC COMPRESSION RELEASE (ACR) TEST	31
CRANKSHAFT END PLAY MEASUREMENT	31
REPAIR	32
CARBURETOR COVER	32
CARBURETOR (CARB/EPA CERTIFIED)	32
FUEL TANK	36
MUFFLER	37
ENGINE	37
STARTING MOTOR	38
ENGINE BLOWER HOUSING	39





INTAKE MANIFOLD 40

FLYWHEEL 40

IGNITION MODULE 41

CYLINDER HEAD 42

CYLINDER HEAD INSPECTION 44

VALVE ASSEMBLY 44

VALVE SPRING INSPECTION 45

VALVE INSPECTION 45

VALVE ANALYSIS 46

VALVE GUIDE INSPECTION 47

VALVE SEAT RECONDITIONING 47

VALVE LAPPING 48

CRANKCASE COVER 48

GOVERNOR 50

COUNTERBALANCE SHAFT—1332DDE 54

CAMSHAFT AND FOLLOWERS 54

PISTON ASSEMBLY 57

PISTON ASSEMBLY/DISASSEMBLY AND VISUAL INSPECTION 58

PISTON CLEANING 58

PISTON RING END GAP MEASUREMENT 58

PISTON RING SIDE CLEARANCE MEASUREMENT 59

PISTON MEASUREMENT 59

PISTON RINGS INSTALLATION 59

CONNECTING ROD INSPECTION AND MEASUREMENT 60

CONNECTING ROD-TO-PISTON INSTALLATION 60

PISTON ASSEMBLY INSTALLATION 61

CRANKSHAFT 62

CYLINDER BLOCK 62

ASSEMBLE ENGINE 64

RECOIL STARTER 64

SPECIFICATIONS



	924DE	1128DE	1128DDE	1332DDE
ENGINE				
Manufacturer	Tecumseh -Snow King	Tecumseh -Snow King	Tecumseh -Snow King	Tecumseh -Snow King
Model	OHSK90	OHSK110	OHSK110	OHSK130
Type (cycle)	4 cycle	4 cycle	4 cycle	4 cycle
Horsepower	6.71 kW (9 hp)	8.20 kW (11 hp)	8.20 kW (11 hp)	9.69 kW (13 hp)
Slow Engine Idle speed	2000 ± 150 rpm	2000 ± 150 rpm	2000 ± 150 rpm	2000 ± 150 rpm
Fast Engine Idle speed	3600 ± 150 rpm	3600 ± 150 rpm	3600 ± 150 rpm	3600 ± 150 rpm
Displacement	318.46 cm ³ (19.43 cu. in.)	318.46 cm ³ (19.43 cu. in.)	318.46 cm ³ (19.43 cu. in.)	357.63 cm ³ (21.82 cu. in.) ³
Bore - Std.	79.375 mm (3.125 in.)	79.375 mm (3.125 in.)	79.375 mm (3.125 in.)	84.125 mm (3.312 in.)
Bore - Max.	79.400 mm (3.126 in.)	79.400 mm (3.126 in.)	79.400 mm (3.126 in.)	84.150 mm (3.313 in.)
Stroke	70.993 mm (2.532 in.)	70.993 mm (2.532 in.)	70.993 mm (2.532 in.)	70.993 mm (2.532 in.)
Lubrication Type	Oil Dipper	Oil Dipper	Oil Dipper	Counterbalance Shaft
Oil capacity	0.77 L (26 U.S. oz)	0.77 L (26 U.S. oz)	0.77 L (26 U.S. oz)	0.95 L (32 U.S. oz)
Oil fill	Tube/dipstick in front of engine	Tube/dipstick in front of engine	Tube/dipstick in front of engine	Tube/dipstick in front of engine
Bearings: PTO/Flywheel	Aluminum alloy	Aluminum alloy	Aluminum alloy	Replaceable bronze bushing
Cylinder	Aluminum	Aluminum with cast iron sleeve	Aluminum with cast iron sleeve	Aluminum with cast iron sleeve
FUEL				
Type required	Unleaded gasoline - 87 octane or higher	Unleaded gasoline - 87 octane or higher	Unleaded gasoline - 87 octane or higher	Unleaded gasoline - 87 octane or higher
Fuel tank	3.8 L (1.0 U.S. gal)	3.8 L (1.0 U.S. gal)	3.8 L (1.0 U.S. gal)	3.8 L (1.0 U.S. gal)
Fuel filter	Fine mesh in fuel tank Fine paper in-line between shut-off & carburetor (optional)	Fine mesh in fuel tank Fine paper in-line between shut-off & carburetor (optional)	Fine mesh in fuel tank Fine paper in-line between shut-off & carburetor (optional)	Fine mesh in fuel tank Fine paper in-line between shut-off & carburetor (optional)

	924DE	1128DE	1128DDE	1332DDE
Carburetor	Float-type with manual choke and primer	Float-type with manual choke and primer	Float-type with manual choke and primer	Float-type with manual choke and primer

ELECTRICAL SPECIFICATIONS



Ignition	Electronic Capacitor Discharge Ignition (CDI) System	Electronic Capacitor Discharge Ignition (CDI) System	Electronic Capacitor Discharge Ignition (CDI) System	Electronic Capacitor Discharge Ignition (CDI) System
Ignition Module Air Gap	0.32 mm (0.013 in.)	0.32 mm (0.013 in.)	0.32 mm (0.013 in.)	0.32 mm (0.013 in.)
Spark plug	RN4C	RN4C	RN4C	RN4C
Spark plug Air Gap	0.762 mm (0.030 in.)	0.762 mm (0.030 in.)	0.762 mm (0.030 in.)	0.762 mm (0.030 in.)
Starting	Standard Recoil Pull Start with Automatic Compression Release (ACR)	Standard Recoil Pull Start with Automatic Compression Release (ACR)	Standard Recoil Pull Start with Automatic Compression Release (ACR)	Standard Recoil Pull Start with Automatic Compression Release (ACR)
Electric start	Standard; 120 V Electric Start Kit	Standard; 120 V Electric Start Kit	Standard; 120 V Electric Start Kit	Standard; 120 V Electric Start Kit
Alternator	18 Watt	18 Watt	3 and 5 Amp	3 and 5 Amp
Headlight	Standard	Standard	Standard	Standard

REPAIR SPECIFICATIONS

Carburetor Float	4.36 mm (11/64 in.)	4.36 mm (11/64 in.)	4.36 mm (11/64 in.)	4.36 mm (11/64 in.)
Camshaft Bearing Journal Dia. (Shaft)	15.82 - 15.84 mm (0.6230 - 0.6235 in.)	15.82 - 15.84 mm (0.6230 - 0.6235 in.)	15.82 - 15.84 mm (0.6230 - 0.6235 in.)	15.82 - 15.84 mm (0.6230 - 0.6235 in.)
Cam Bearing Inside Dia. (Cover/Block)	15.86 - 15.89 mm (0.6245 - 0.6255 in.)	15.86 - 15.89 mm (0.6245 - 0.6255 in.)	15.86 - 15.89 mm (0.6245 - 0.6255 in.)	15.86 - 15.89 mm (0.6245 - 0.6255 in.)
Crankshaft Dia. Flywheel End	34.912 - 34.925 mm (1.3745 - 1.3750 in.)	34.912 - 34.925 mm (1.3745 - 1.3750 in.)	34.912 - 34.925 mm (1.3745 - 1.3750 in.)	34.912 - 34.925 mm (1.3745 - 1.3750 in.)
Crankpin Journal Dia.	34.900 - 34.912 mm (1.3740 - 1.3745 in.)	34.900 - 34.912 mm (1.3740 - 1.3745 in.)	34.900 - 34.912 mm (1.3740 - 1.3745 in.)	34.900 - 34.912 mm (1.3740 - 1.3745 in.)
Crankshaft Dia. PTO End	34.912 - 34.925 mm (1.3745 - 1.3750 in.)	34.912 - 34.925 mm (1.3745 - 1.3750 in.)	34.912 - 34.925 mm (1.3745 - 1.3750 in.)	34.912 - 34.925 mm (1.3745 - 1.3750 in.)
Crankshaft End Play	0.05 - 1.06 mm (0.002 - 0.042 in.)	0.05 - 1.06 mm (0.002 - 0.042 in.)	0.05 - 1.06 mm (0.002 - 0.042 in.)	0.05 - 1.06 mm (0.002 - 0.042 in.)
Cover Bearing Inside Dia.	34.963 - 34.976 mm (1.3765 - 1.3770 in.)	34.963 - 34.976 mm (1.3765 - 1.3770 in.)	34.963 - 34.976 mm (1.3765 - 1.3770 in.)	34.963 - 34.976 mm (1.3765 - 1.3770 in.)



	924DE	1128DE	1128DDE	1332DDE
Block Bearing Inside Dia.	34.963 - 34.976 mm (1.3765 - 1.3770 in.)	34.963 - 34.976 mm (1.3765 - 1.3770 in.)	34.963 - 34.976 mm (1.3765 - 1.3770 in.)	34.963 - 34.976 mm (1.3765 - 1.3770 in.)
Connecting Rod Crank Bearing Bore ID	34.988 - 35.001 mm (1.3775 - 1.3780 in.)	34.988 - 35.001 mm (1.3775 - 1.3780 in.)	34.988 - 35.001 mm (1.3775 - 1.3780 in.)	34.988 - 35.001 mm (1.3775 - 1.3780 in.)
Cylinder Bore ID	79.375 - 79.400 mm (1.3775 - 1.3780 in.)	79.375 - 79.400 mm (1.3775 - 1.3780 in.)	79.375 - 79.400 mm (1.3775 - 1.3780 in.)	84.125 - 84.150 mm (3.312 - 3.313 in.)
Piston Diameter (Bottom Skirt)	79.235 - 79.261 mm (3.1195 - 3.1205 in.)	79.235 - 79.261 mm (3.1195 - 3.1205 in.)	79.235 - 79.261 mm (3.1195 - 3.1205 in.)	84.061 - 84.087 mm (3.3095 - 3.3105 in.)
	(as measured from 6.35 mm (0.25 in.) from bottom of skirt and 180° from center of piston pin hole)			
Piston-To-Cylinder Bore Clearance	0.038 - 0.089 mm (0.0015 - 0.0035 in.)	0.038 - 0.089 mm (0.0015 - 0.0035 in.)	0.038 - 0.089 mm (0.0015 - 0.0035 in.)	0.038 - 0.089 mm (0.0015 - 0.0035 in.)
Piston Ring Side Clearance: TOP/BOT Comp.	0.051 - 0.127 mm (0.002 - 0.004 in.)	0.051 - 0.127 mm (0.002 - 0.004 in.)	0.051 - 0.127 mm (0.002 - 0.004 in.)	0.051 - 0.127 mm (0.002 - 0.004 in.)
Piston Ring Side Clearance: Oil Control	0.025 - 0.076 mm (0.001 - 0.003 in.)	0.025 - 0.076 mm (0.001 - 0.003 in.)	0.025 - 0.076 mm (0.001 - 0.003 in.)	0.025 - 0.076 mm (0.001 - 0.003 in.)
Piston Ring End Gap	0.254 - 0.508 mm (0.010 - 0.020 in.)	0.254 - 0.508 mm (0.010 - 0.020 in.)	0.254 - 0.508 mm (0.010 - 0.020 in.)	0.254 - 0.508 mm (0.010 - 0.020 in.)
Valve-To-Rocker Arm Clearance	0.1016 mm (0.004 in.)	0.1016 mm (0.004 in.)	0.1016 mm (0.004 in.)	0.1016 mm (0.004 in.)
Valve Seat Width	0.89 - 1.14 mm (0.035 - 0.046 in.)	0.89 - 1.14 mm (0.035 - 0.046 in.)	0.89 - 1.14 mm (0.035 - 0.046 in.)	0.89 - 1.14 mm (0.035 - 0.046 in.)
Valve Guide Oversize Diameter	8.717 - 8.743 mm (0.343 - 0.344 in.)	8.717 - 8.743 mm (0.343 - 0.344 in.)	8.717 - 8.743 mm (0.343 - 0.344 in.)	8.717 - 8.743 mm (0.343 - 0.344 in.)
Piston Bore Cross. Pattern	45 degrees	45 degrees	45 degrees	45 degrees
Cylinder Head Dist. (Max.)	0.127 mm (0.005 in.)	0.127 mm (0.005 in.)	0.127 mm (0.005 in.)	0.127 mm (0.005 in.)
Governor Shaft Exp. Length	33.27 mm (1.31 in.)	33.27 mm (1.31 in.)	33.27 mm (1.31 in.)	33.27 mm (1.31 in.)

TORQUE SPECIFICATIONS

Rocker Cover Studs	6 N•m (55 lb-in.)	6 N•m (55 lb-in.)	6 N•m (55 lb-in.)	6 N•m (55 lb-in.)
Rocker Arm Lock Nut	13.5 N•m (120 lb-in.)	13.5 N•m (120 lb-in.)	13.5 N•m (120 lb-in.)	13.5 N•m (120 lb-in.)
Cylinder Head Cap Screw	26 N•m (230 lb-in.)	26 N•m (230 lb-in.)	26 N•m (230 lb-in.)	26 N•m (230 lb-in.)
Flywheel Nut	79 N•m (58 lb-ft)	79 N•m (58 lb-ft)	79 N•m (58 lb-ft)	79 N•m (58 lb-ft)

	924DE	1128DE	1128DDE	1332DDE
Intake Manifold Cap Screw	13 N•m (115 lb-in.)	13 N•m (115 lb-in.)	13 N•m (115 lb-in.)	13 N•m (115 lb-in.)
Muffler Cap Screw	22.5 N•m (200 lb-in.)	22.5 N•m (200 lb-in.)	22.5 N•m (200 lb-in.)	22.5 N•m (200 lb-in.)
Exhaust Manifold	18 N•m (160 lb-in.)	18 N•m (160 lb-in.)	18 N•m (160 lb-in.)	18 N•m (160 lb-in.)
Carburetor Mtg. Cap Screw	8 N•m (70 lb-in.)	8 N•m (70 lb-in.)	8 N•m (70 lb-in.)	8 N•m (70 lb-in.)
Connecting Rod Cap Screw	24 N•m (210 lb-in.)	24 N•m (210 lb-in.)	24 N•m (210 lb-in.)	24 N•m (210 lb-in.)
Crankcase Cover Cap Screw*	14 N•m (125 lb-in.)	14 N•m (125 lb-in.)	14 N•m (125 lb-in.)	14 N•m (125 lb-in.)
Spark Plug	28.5 N•m (250 lb-in.)	28.5 N•m (250 lb-in.)	28.5 N•m (250 lb-in.)	28.5 N•m (250 lb-in.)
Ignition Module	5 N•m (44 lb-in.)	5 N•m (44 lb-in.)	5 N•m (44 lb-in.)	5 N•m (44 lb-in.)
Electric Starter	11 N•m (100 lb-in.)	11 N•m (100 lb-in.)	11 N•m (100 lb-in.)	11 N•m (100 lb-in.)
Alternator Coil	10 N•m (90 lb-in.)	10 N•m (90 lb-in.)	10 N•m (90 lb-in.)	10 N•m (90 lb-in.)
Magneto Stator	7.5 N•m (66 lb-in.)	7.5 N•m (66 lb-in.)	7.5 N•m (66 lb-in.)	7.5 N•m (66 lb-in.)
Recoil Starter	5.5 - 9 N•m (50 - 80 lb-in.)	5.5 - 9 N•m (50 - 80 lb-in.)	5.5 - 9 N•m (50 - 80 lb-in.)	5.5 - 9 N•m (50 - 80 lb-in.)

*Apply LOCTITE® #242 (John Deere #T43512 - Medium Strength) to first few threads of cap screw.



OTHER MATERIALS

<u>Number & Name</u>	<u>Use</u>
John Deere NEVER-SEEZ® Lubricant PT569	Apply to crankshaft end.
LOCTITE® PRODUCTS:	
(U.S. / Canadian) John Deere No. (Loctite No.)	
T43512 (#242) (Medium Strength)	Apply to governor shaft.
	Apply to crankcase cover cap screws.
® LOCTITE is a registered trademark of the Loctite Corp.	





SPECIAL TOOLS



<u>Number & Name</u>	<u>Use</u>
JDG488 Seal Installer	Install flywheel end crankshaft oil seal.
JDG489 Seal Installer	Install PTO end crankshaft oil seal.
JDM52A Valve Seat Service Set	Resurface valve seats.
D05058ST Valve Inspection Center	Inspect intake and exhaust valves.
JDM15 Dial Indicator Kit.	Measures valve head diameter
D05351ST Spark Tester.	Test state of ignition system.
D17001BR Flex Hone	Final honing of cylinder on 924DE.
D17002BR Flex Hone	Final honing of cylinder on 1128DE, 1128DDE, and 1332DDE.
JDG332 Telescoping Gauge Set	Measurements for wear tolerances.
JDG1322 Piston Ring Compressor	Compression of piston rings during piston installation.
JDG438 Ring Groove Cleaner	Cleaning of ring grooves on piston.
JDM54 or JDM55 Valve Lapper	Lapping valve and valve seat mating surfaces.
JDM62 Glaze Breaker	Removing glaze ring from cylinder.
JDM63 Rigid Cylinder Hone Set	Initial honing of cylinder.
JDM70 Valve Spring Compressor	Remove valve springs.
JDM74A-5 Spark Plug Ground Tool.	Grounds and protects ignition system.
JT02153 Current Clamp-On Probe	Test related electrical system components.
JT03503 Vacuum Gauge Test Kit.	Measure crankcase vacuum.
JT05697 U-Tube Manometer Vacuum Test Kit.	Measure crankcase vacuum.
JT05791 Analog/Digital Multimeter	Test related electrical system components.
JT07270 Digital Pulse Tachometer.	Test engine speed.
JT07363 Dial Indicator Kit	Measure crankshaft end play.
Wire Feeler Gauge.	Set spark plug air gap.
Flat Feeler Gauge	Set valve-to-tappet clearance.
Outside Micrometer	Measurements for wear tolerances.
Inside/Outside Dial Calipers.	Measurements for wear tolerances.
Piston Ring Expander Tool.	Expansion of piston rings for removal/installation

TRUBLESHOOTING

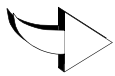
ENGINE TROUBLESHOOTING CHARTS



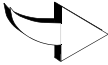

Problem or Symptom 	Check or Solution 													
	Engine will not crank	Engine cranks but will not start or starts hard	Engine has low power or runs very poorly	Engine fuel/air supply inadequate	Engine has no spark	Engine misfires	Engine surges or over-speeds	Engine floods	Engine has blue exhaust smoke	Engine has black exhaust smoke	Engine uses too much oil	Engine backfires thru carburetor	Engine backfires thru muffler	Engine spark plug fouled
FUEL/AIR SYSTEM: Plugged tank filter or vent	●			●										
Fuel shut-off valve not fully opened or tank empty	●	●	●	●										
Primer over-used or faulty	●			●			●		●				●	
Plugged or restricted line	●	●	●	●										
Loose or damaged line	●	●	●	●										
Carb. fuel inlet plugged	●			●										
Carb. bowl o-ring seal leaky	●	●	●	●										
Carb. air intake restricted	●	●	●	●										
Carb. atmospheric vent restricted	●	●	●	●										
Carb. air bleed restricted	●	●	●	●										
Carb. idle port restricted	●	●	●	●										
Carb. float height incorrect	●	●	●	●		●	●		●		●	●	●	
Carb. main nozzle restricted	●	●	●	●										
Carb. inlet needle and seat dirty or stuck	●	●	●	●			●		●		●	●	●	
Fuel stale, contains water, or wrong type	●	●	●	●	●									

Problem or Symptom 	Check or Solution 													
	Engine will not crank	Engine cranks but will not start or starts hard	Engine has low power or runs very poorly	Engine fuel/air supply inadequate	Engine has no spark	Engine misfires	Engine surges or over-speeds	Engine floods	Engine has blue exhaust smoke	Engine has black exhaust smoke	Engine uses too much oil	Engine backfires thru carburetor	Engine backfires thru muffler	Engine spark plug fouled
Governor and linkage set improperly		●	●	●			●							
Choke or throttle plates/linkage worn or misadjusted		●	●	●			●			●		●	●	●
Carburetor too rich		●	●			●	●			●		●	●	●
Carburetor too lean		●	●	●		●								
Carburetor loose on mounting		●	●	●		●	●							●
Carb. contaminated with debris or varnish		●	●	●										
ELECTRICAL SYSTEM: Spark plug fouled, defective, gap not correct or incorrect spark plug		●	●	●	●	●		●		●		●	●	●
Defective ignition components		●	●	●	●	●		●		●		●	●	
Starting motor worn or defective, cranking rpm too slow, cables corroded/broke, or switch faulty	●	●			●			●						
ENGINE: Engine overloaded or throttle not at FAST position	●	●	●	●										●
Carburetor, intake manifold, or cylinder head gaskets leaking or damaged		●	●			●				●				●
Low compression from worn piston, rings, cylinder, valves or warped head		●	●					●		●				●



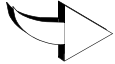

Problem or Symptom 	Check or Solution 													
	Engine will not crank	Engine cranks but will not start or starts hard	Engine has low power or runs very poorly	Engine fuel/air supply inadequate	Engine has no spark	Engine misfires	Engine surges or over-speeds	Engine floods	Engine has blue exhaust smoke	Engine has black exhaust smoke	Engine uses too much oil	Engine backfires thru carburetor	Engine backfires thru muffler	Engine spark plug fouled
Valve clearance incorrect, burned or warped valves and seats, or defective springs		●	●			●	●			●	●	●	●	●
Engine oil viscosity or level incorrect	●	●	●					●		●				●
Engine main seals leaking		●	●					●		●				●
Crankcase breather restricted, clearance incorrect, or drain hole plugged		●	●					●		●		●	●	
Valve guides or seals worn or leaking, or valve stems worn.		●	●			●				●		●		●
Worn, stuck, or broken piston rings, cylinder bore worn, compression and vacuum low	●	●	●			●		●		●				●
Connecting rod or crankshaft bearings worn, internal wear limits out of specification	●	●	●			●				●				●
Engine mounting hardware loose, broken, or missing			●											●
RECOIL START SYSTEM: Recoil spring weak, broke or dislodged	●													●
Rope dislodged from spool or tangled	●													
Dogs or dog springs worn, weak, broke, or dislodged	●													●
Brake spring worn, weak, or broke	●													●

DIAGNOSTICS

ENGINE WILL NOT CRANK (RECOIL STARTER)

Test Conditions:

- Machine on level surface, key switch “OFF”
- Transmission control in “NEUTRAL”
- Auger drive disengaged
- Friction drive disengaged



Test/Check Point	Normal	If Not Normal
1. Gently pull on starter handle and watch engine output shafts.	Engine output shafts turn over.	Remove recoil starter assembly and check recoil starter for malfunction.
2. Remove recoil starter and install socket and breaker bar on flywheel nut or cap screw and turn clockwise.	Flywheel and output shafts turn over.	Remove flywheel and check key and keyway for damage.
3. With flywheel removed, install flywheel nut or cap screw on or in end of crankshaft and turn clockwise with socket and breaker bar.	Output shafts turn over.	Tear engine down and check for malfunction.

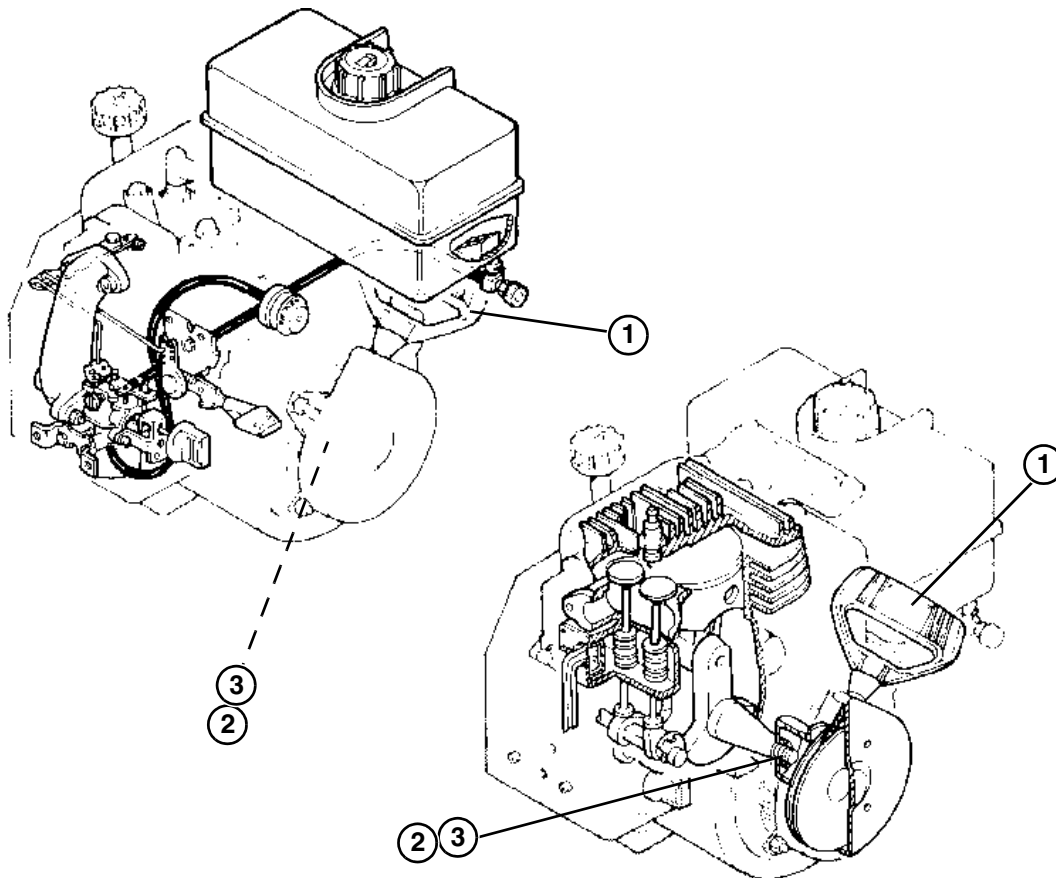

M70862

ENGINE TURNS OVER BUT WILL NOT START

ENGINE

Product: John Deere 924DE/1128DE/1128DDE/1332DDE Walk-Behind Snowblowers Service Repair Technical Manual

Full Download: <https://www.bobmanualstore.com/downloads/john-deere-924de-1128de-1128dde-1332dde-walk-behind-snowblowers-service-repair-technical-manual>

ENGINE TURNS OVER BUT WILL NOT START

Test Conditions:

- Key switch "OFF"
- Transmission control in "NEUTRAL"
- Auger drive disengaged
- Friction drive disengaged



Test/Check Point	Normal	If Not Normal
1. Spark plug (check for fuel and correct gap)	Plug dry and gap set at 0.76 mm (0.030 in.)	Check carburetor float for engine flooding, clean plug, and set gap.
2. Spark plug (test spark)	Good hot spark	Check ignition circuit. Replace spark plug.
3. Carburetor bowl nut (check for fuel in float bowl. Inspect and clean nut orifice)	Fuel present, bowl clean	Check for lack of fuel in carburetor.
4. Carburetor (check choke adjustment)	Choke plate fully closed with choke control at "Full"	Adjust choke components.

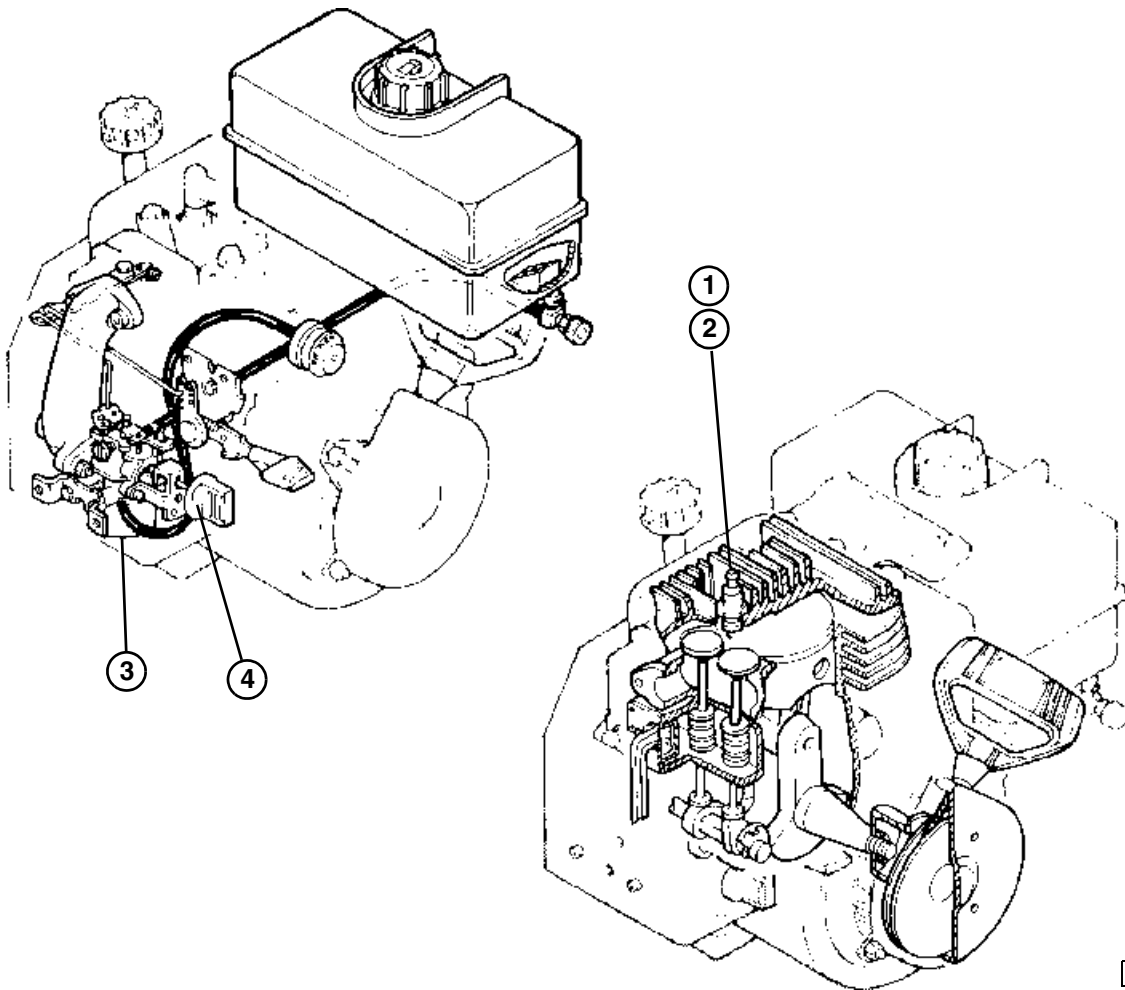

M70862

Sample manual. Download All 174 pages at:

<https://www.bobmanualstore.com/downloads/john-deere-924de-1128de-1128dde-1332dde-walk-behind-snowblowers-service-repair-technical-manual>