

410E Backhoe Loader Repair

TECHNICAL MANUAL

TM1611 22JUL10 (ENGLISH)

For complete service information also see:

410E Backhoe Loader Repair (Complete)	TM1611
410E Backhoe Loader Operation and Test (Complete).....	TM1610
POWERTECH® 4.5 L (4045) Engine	CTM104
Alternators and Starting Motors	CTM77
Front Wheel Drive Axles APL-2025.....	CTM4509

**Worldwide Construction
And Forestry Division**
LITHO IN U.S.A.

Sample manual. Download All 792 pages at:

<https://www.bobmanualstore.com/downloads/john-deere-410e-backhoe-loader-service-repair-technical-manual/>

Introduction

Foreword

This manual is written for an experienced technician. Essential tools required in performing certain service work are identified in this manual and are recommended for use.

Live with safety: Read the safety messages in the introduction of this manual and the cautions presented throughout the text of the manual.

 This is the safety-alert symbol. When you see this symbol on the machine or in this manual, be alert to the potential for personal injury.

Technical manuals are divided in two parts: repair and operation and tests. Repair sections tell how to repair the components. Operation and tests sections help you identify the majority of routine failures quickly.

Information is organized in groups for the various components requiring service instruction. At the beginning of each group are summary listings of all applicable essential tools, service equipment and tools, other materials needed to do the job, service parts kits, specifications, wear tolerances, and torque values.

Technical Manuals are concise guides for specific machines. They are on-the-job guides containing only the vital information needed for diagnosis, analysis, testing, and repair.

Fundamental service information is available from other sources covering basic theory of operation, fundamentals of troubleshooting, general maintenance, and basic type of failures and their causes.

See DB1990 Service Publications Catalog to order a complete Technical Manual (TM) or a Technical Manual Section (TMS). A complete Repair manual includes the following sections:

- TMS161100 Section 00 General Information
- TMS161101 Sections 01—02 Wheels and Axles
- TMS161103 Sections 03—06 Transmission and Engine
- TMS161109 Sections 09—11 Steering and Brakes
- TMS161116 Sections 16—17 Electrical System and Frame
- TMS161118 Sections 18—20 Operator's Station and Sheet Metal
- TMS161121 Sections 21, 31, 33 Main Hydraulics

TX,INTR,SS3531 -19-11DEC96-1/1

John Deere Dealers

IMPORTANT: Please remove this page and route through your service department.

Listed below is a brief explanation of “WHAT” was change and “WHY” it was changed.

These sectionalized manuals were revised to include the following changes:

1. Section 00:
To include any specifications, oil capacity and miscellaneous changes.
2. Section 01—02:
Miscellaneous wheel specification changes and service brake check added.
3. Section 03—06:
Transmission clutch pack bottom of gear to top of drum distance specification change, miscellaneous changes in charge pump and manifold plate solenoids procedures.
4. Engine flywheel turning tool number change. Fan cap screw torque added.
5. Section 09—11:
Steering valve manual check valve change. Miscellaneous brake valve changes.
6. Section 16—17:
Torque added to engine coolant temperature switch.
7. Section 18—20:
Cab side window torque and thread lock and sealer added. Bushings added to guide on upper rear window. Air suspension seat procedure added.
8. Section 21, 31 and 33:
Torque added to hydraulic pump unloader relief valve. Cooler options added. Multi-purpose bucket and lines added. Shim as required added to bucket links-to-cylinder. Loader control relief valves torques, graphics and procedure changes. Loader cylinder miscellaneous changes. Backhoe linkage changes. Backhoe boom swing lock arms and locking pin added. Stabilizer valve linkage updates and serial number breaks. Miscellaneous changes to extensible dipperstick and sideshift frame locking pistons. Backhoe control relief valves torques, graphics and procedure changes. Backhoe cylinders serial number breaks and procedure changes. Extendible dipperstick disassemble and assemble procedure added.

CED, TX03399, 5903 -19-13JAN00-1/1

Technical Information Feedback Form

We need your help to continually improve our technical publications. Please copy this page and FAX or mail your comments, ideas and improvements.

SEND TO: John Deere Dubuque Works
18600 South John Deere Road
Attn: Publications, Dept. 324
Dubuque, IA 52004-0538
USA

FAX NUMBER: 1-563-589-5800 (USA)

Publication Number: _____

Page Number: _____

Ideas, Comments: _____

Name: _____

Phone: _____

Email Address: _____

THANK YOU!

TX,TM,FAX -19-03JUL01-1/1

Contents

Section 00—General Information

- Group 0001—Safety Information
- Group 0002—General Specifications
- Group 0003—Torque Values
- Group 0004—Fuels and Lubricants

Section 01—Wheels

- Group 0110—Powered or Non-Powered Wheels and Fastenings

Section 02—Axles and Suspension Systems

- Group 0225—Input Drive Shafts and U-Joints
- Group 0230—Non-Powered Wheel Axles
- Group 0240—Powered Wheel Axle (MFWD)
- Group 0250—Axle Shaft, Bearings and Reduction Gears
- Group 0299—Dealer Fabricated Tools

Section 03—Transmission

- Group 0300—Removal and Installation
- Group 0315—Controls Linkage
- Group 0325—Input Drive Shafts and U-Joint
- Group 0350—Gears, Shafts, Bearings, and Powershift Clutches
- Group 0360—Hydraulic System
- Group 0399—Dealer Fabricated Tools

Section 04—Engine

- Group 0400—Removal and Installation
- Group 0499—Dealer Fabricated Tools

Section 05—Engine Auxiliary Systems

- Group 0505—Cold Weather Starting Aid
- Group 0510—Cooling Systems
- Group 0515—Speed Controls
- Group 0520—Intake System
- Group 0530—Exhaust System
- Group 0560—External Fuel Supply System

Section 06—Torque Converter

- Group 0651—Turbine, Gears and Shaft

Section 09—Steering System

- Group 0960—Hydraulic System

Section 10—Service Brakes

- Group 1011—Active Elements

- Group 1060—Hydraulic System

Section 11—Park Brake

- Group 1111—Active Elements

Section 16—Electrical Systems

- Group 1671—Batteries, Support, and Cables
- Group 1672—Alternator, Regulator and Charging System Wiring
- Group 1673—Lighting System
- Group 1674—Wiring Harness and Switches
- Group 1675—System Controls
- Group 1676—Instruments and Indicators
- Group 1677—Motors and Actuators

Section 17—Frames, Chassis or Supporting Structure

- Group 1740—Frame Installation
- Group 1749—Chassis Weights

Section 18—Operator's Station

- Group 1800—Removal and Installation
- Group 1810—Operator Enclosure
- Group 1821—Seat and Seat Belt
- Group 1830—Heating and Air Conditioning
- Group 1899—Dealer Fabricated Tools

Section 19—Sheet Metal and Styling

- Group 1910—Hood and Engine Enclosure
- Group 1913—Miscellaneous Shields
- Group 1921—Grille and Grille Housing
- Group 1927—Fenders

Section 20—Safety, Convenience and Miscellaneous

- Group 2001—Radio
- Group 2004—Horn and Warning Devices

Section 21—Main Hydraulic System

- Group 2160—Hydraulic System

Section 31—Loader

- Group 3100—Loader
- Group 3102—Bucket
- Group 3115—Control Linkages
- Group 3160—Hydraulic System

Continued on next page

Original Instructions. All information, illustrations and specifications in this manual are based on the latest information available at the time of publication. The right is reserved to make changes at any time without notice.

COPYRIGHT © 2002
DEERE & COMPANY
Moline, Illinois
All rights reserved.
A John Deere ILLUSTRATION © Manual
Previous Editions
Copyright © 1997, 1999, 2000

Section 33—Backhoe

Group 3302—Bucket

Group 3315—Control Linkage

Group 3340—Frames

Group 3360—Hydraulic System

Section 00 General Information

Contents

	Page		Page
Group 0001—Safety Information		Metric Bolt and Screw Torque Values	00-0003-2
Handle Fluids Safely—Avoid Fires	00-0001-1	Additional Metric Cap Screw Torque Values	00-0003-3
Prevent Battery Explosions	00-0001-1	Unified Inch Bolt and Screw Torque Values	00-0003-4
Prepare for Emergencies	00-0001-1	O-Ring Groove Connections	00-0003-5
Prevent Acid Burns	00-0001-2	Check Oil Lines And Fittings	00-0003-5
Handle Chemical Products Safely	00-0001-2	Service Recommendations for O-Ring Boss Fittings	00-0003-6
Avoid High-Pressure Fluids	00-0001-3	Service Recommendations for Flat Face O-Ring Seal Fittings	00-0003-7
Park Machine Safely	00-0001-3	Service Recommendations for Metric Series Four Bolt Flange Fitting	00-0003-8
Support Machine Properly	00-0001-3	Service Recommendations For Inch Series Four Bolt Flange Fittings	00-0003-9
Wear Protective Clothing	00-0001-4	Group 0004—Fuels and Lubricants	
Work in Clean Area	00-0001-4	Diesel Fuel	00-0004-1
Service Machines Safely	00-0001-4	Low Sulfur Diesel Fuel Conditioner	00-0004-1
Work In Ventilated Area	00-0001-5	Handling and Storing Diesel Fuel	00-0004-2
Illuminate Work Area Safely	00-0001-5	Do Not Use Galvanized Containers	00-0004-2
Replace Safety Signs	00-0001-5	Heavy Duty Diesel Engine Coolant	00-0004-3
Use Proper Lifting Equipment	00-0001-6	Fuel Tank	00-0004-3
Remove Paint Before Welding or Heating	00-0001-6	Diesel Engine Oil	00-0004-4
Avoid Heating Near Pressurized Fluid Lines	00-0001-6	Transmission, Axle, and Mechanical Front Wheel Drive Oil	00-0004-5
Keep ROPS Installed Properly	00-0001-7	Hydraulic Oil	00-0004-5
Service Tires Safely	00-0001-7	Grease	00-0004-7
Practice Safe Maintenance	00-0001-8	Grease for Extendible Dipperstick, Sideshift Frame, and Stabilizer Leg Wear Strips	00-0004-7
Use Proper Tools	00-0001-8	Alternative and Synthetic Lubricants	00-0004-7
Dispose of Waste Properly	00-0001-9	Lubricant Storage	00-0004-8
Live With Safety	00-0001-9	Mixing of Lubricants	00-0004-8
Group 0002—General Specifications			
410E Backhoe Loader Dimensions	00-0002-1		
410E Backhoe Loader Specifications	00-0002-6		
Other Information—410E Backhoe Loader	00-0002-8		
410E Backhoe Loader Weight	00-0002-8		
410E Backhoe and Loader Buckets	00-0002-9		
410E Backhoe Loader Drain and Refill Capacities	00-0002-9		
410E Backhoe Loader Lifting Capacities—Standard Dipperstick	00-0002-10		
410E Backhoe Loader Lifting Capacities—Extendible Dipperstick (Retracted)	00-0002-11		
410E Backhoe Loader Lifting Capacities—Extendible Dipperstick (Extended)	00-0002-12		
Group 0003—Torque Values			
Hardware Torque Specifications	00-0003-1		
ROPS Torque Specifications	00-0003-1		

Contents

Handle Fluids Safely—Avoid Fires

When you work around fuel, do not smoke or work near heaters or other fire hazards.

Store flammable fluids away from fire hazards. Do not incinerate or puncture pressurized containers.

Make sure machine is clean of trash, grease, and debris.

Do not store oily rags; they can ignite and burn spontaneously.



TS227—UN—23AUG88

DX,FLAME -19-29SEP98-1/1

Prevent Battery Explosions

Keep sparks, lighted matches, and open flame away from the top of battery. Battery gas can explode.

Never check battery charge by placing a metal object across the posts. Use a volt-meter or hydrometer.

Do not charge a frozen battery; it may explode. Warm battery to 16°C (60°F).



TS204—UN—23AUG88

DX,SPARKS -19-03MAR93-1/1

Prepare for Emergencies

Be prepared if a fire starts.

Keep a first aid kit and fire extinguisher handy.

Keep emergency numbers for doctors, ambulance service, hospital, and fire department near your telephone.

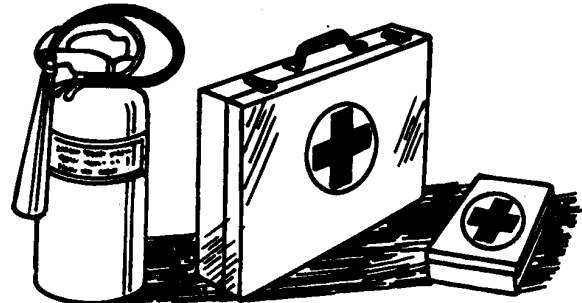

TS291—UN—23AUG88

DX,FIRE2 -19-03MAR93-1/1

Prevent Acid Burns

Sulfuric acid in battery electrolyte is poisonous. It is strong enough to burn skin, eat holes in clothing, and cause blindness if splashed into eyes.

Avoid the hazard by:

1. Filling batteries in a well-ventilated area.
2. Wearing eye protection and rubber gloves.
3. Avoiding breathing fumes when electrolyte is added.
4. Avoiding spilling or dripping electrolyte.
5. Use proper jump start procedure.

If you spill acid on yourself:

1. Flush your skin with water.
2. Apply baking soda or lime to help neutralize the acid.
3. Flush your eyes with water for 15—30 minutes. Get medical attention immediately.

If acid is swallowed:

1. Do not induce vomiting.
2. Drink large amounts of water or milk, but do not exceed 2 L (2 quarts).
3. Get medical attention immediately.

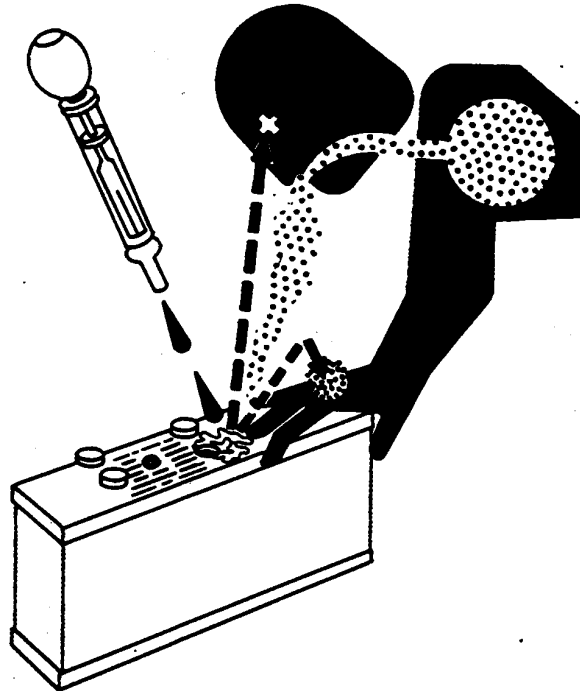

TS203—UN—23AUG88

DX,POISON -19-21APR93-1/1

Handle Chemical Products Safely

Direct exposure to hazardous chemicals can cause serious injury. Potentially hazardous chemicals used with John Deere equipment include such items as lubricants, coolants, paints, and adhesives.

A Material Safety Data Sheet (MSDS) provides specific details on chemical products: physical and health hazards, safety procedures, and emergency response techniques.

Check the MSDS before you start any job using a hazardous chemical. That way you will know exactly what the risks are and how to do the job safely. Then follow procedures and recommended equipment.

(See your John Deere dealer for MSDS's on chemical products used with John Deere equipment.)



TS1132—UN—26NOV90

DX,MSDS,NA -19-03MAR93-1/1

Safety Information

Avoid High-Pressure Fluids

Escaping fluid under pressure can penetrate the skin causing serious injury.

Avoid the hazard by relieving pressure before disconnecting hydraulic or other lines. Tighten all connections before applying pressure.

Search for leaks with a piece of cardboard. Protect hands and body from high-pressure fluids.

If an accident occurs, see a doctor immediately. Any fluid injected into the skin must be surgically removed within a few hours or gangrene may result. Doctors unfamiliar with this type of injury should reference a knowledgeable medical source. Such information is available in English from Deere & Company Medical Department in

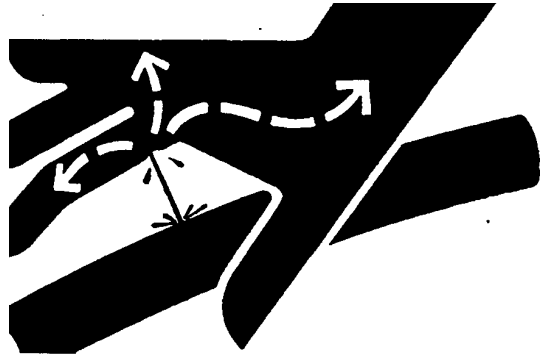

Moline, Illinois, U.S.A., by calling 1-800-822-8262 or +1 309-748-5636.

X9811 —UN—23AUG88

DX,FLUID -19-20AUG09-1/1

Park Machine Safely

Before working on the machine:

- Lower all equipment to the ground.
- Stop the engine and remove the key.
- Disconnect the battery ground strap.
- Hang a "DO NOT OPERATE" tag in operator station.

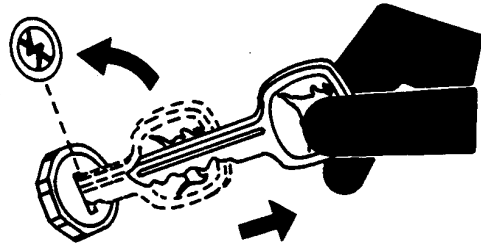

TS230 —UN—24MAY89

DX,PARK -19-04JUN90-1/1

Support Machine Properly

Always lower the attachment or implement to the ground before you work on the machine. If the work requires that the machine or attachment be lifted, provide secure support for them. If left in a raised position, hydraulically supported devices can settle or leak down.

Do not support the machine on cinder blocks, hollow tiles, or props that may crumble under continuous load. Do not work under a machine that is supported solely by a jack. Follow recommended procedures in this manual.

When implements or attachments are used with a machine, always follow safety precautions listed in the implement or attachment operator's manual.

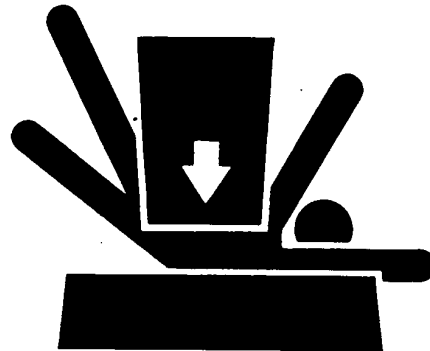

TS229 —UN—23AUG88

DX,LOWER -19-24FEB00-1/1

Safety Information

Wear Protective Clothing

Wear close fitting clothing and safety equipment appropriate to the job.

Operating equipment safely requires the full attention of the operator. Do not wear radio or music headphones while operating machine.

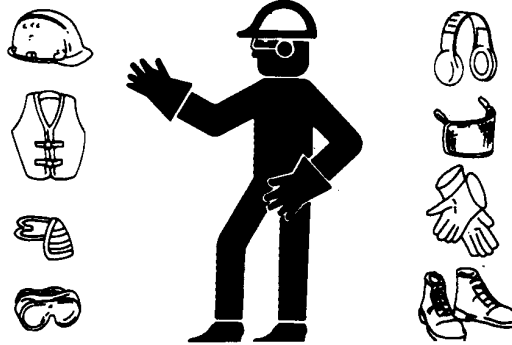

TS206—UN—23AUG88

DX,WEAR2 -19-03MAR93-1/1

Work in Clean Area

Before starting a job:

- Clean work area and machine.
- Make sure you have all necessary tools to do your job.
- Have the right parts on hand.
- Read all instructions thoroughly; do not attempt shortcuts.

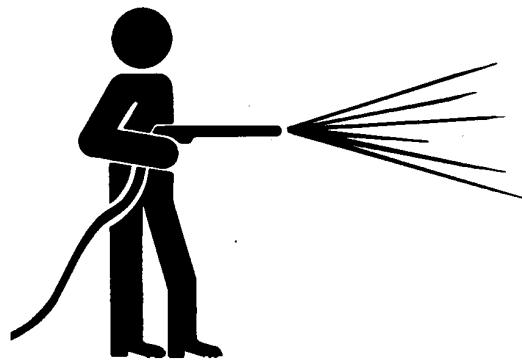

T6642EJ—UN—18OCT88

DX,CLEAN -19-04JUN90-1/1

Service Machines Safely

Tie long hair behind your head. Do not wear a necktie, scarf, loose clothing, or necklace when you work near machine tools or moving parts. If these items were to get caught, severe injury could result.

Remove rings and other jewelry to prevent electrical shorts and entanglement in moving parts.

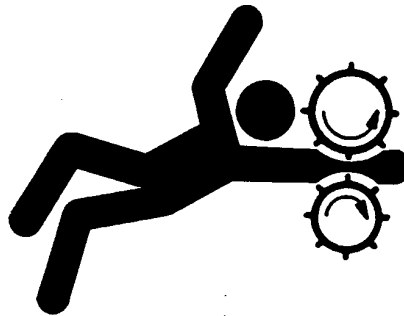

TS228—UN—23AUG88

DX,LOOSE -19-04JUN90-1/1

Safety Information

Work In Ventilated Area

Engine exhaust fumes can cause sickness or death. If it is necessary to run an engine in an enclosed area, remove the exhaust fumes from the area with an exhaust pipe extension.

If you do not have an exhaust pipe extension, open the doors and get outside air into the area.

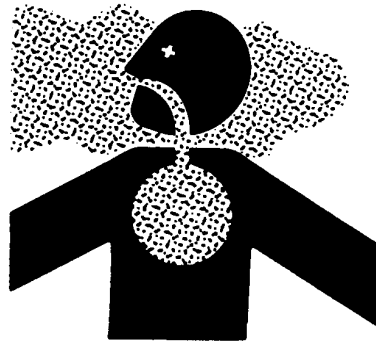

TS220 —UN—23AUG88

DX,AIR -19-17FEB99-1/1

Illuminate Work Area Safely

Illuminate your work area adequately but safely. Use a portable safety light for working inside or under the machine. Make sure the bulb is enclosed by a wire cage. The hot filament of an accidentally broken bulb can ignite spilled fuel or oil.

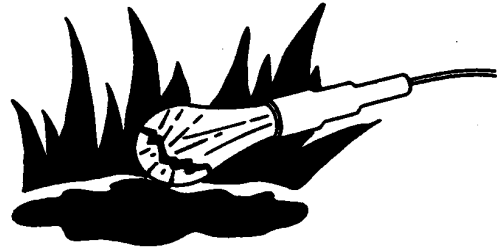

TS223 —UN—23AUG88

DX,LIGHT -19-04JUN90-1/1

Replace Safety Signs

Replace missing or damaged safety signs. See the machine operator's manual for correct safety sign placement.

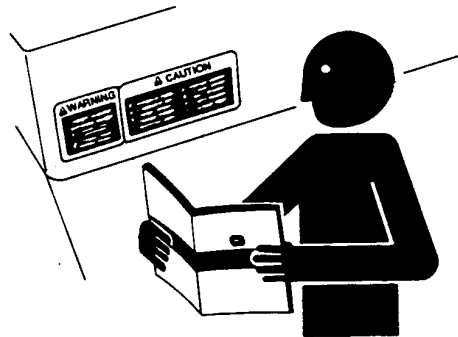

TS201 —UN—23AUG88

DX,SIGNS1 -19-04JUN90-1/1

Use Proper Lifting Equipment

Lifting heavy components incorrectly can cause severe injury or machine damage.

Follow recommended procedure for removal and installation of components in the manual.

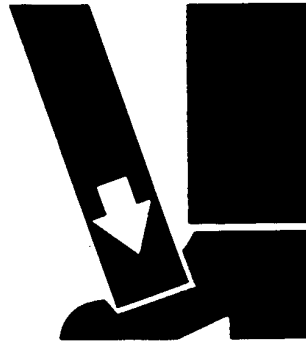

TS226—UN—23AUG88

DX,LIFT -19-04JUN90-1/1

Remove Paint Before Welding or Heating

Avoid potentially toxic fumes and dust.

Hazardous fumes can be generated when paint is heated by welding, soldering, or using a torch.

Remove paint before heating:

- Remove paint a minimum of 100 mm (4 in.) from area to be affected by heating. If paint cannot be removed, wear an approved respirator before heating or welding.
- If you sand or grind paint, avoid breathing the dust. Wear an approved respirator.
- If you use solvent or paint stripper, remove stripper with soap and water before welding. Remove solvent or paint stripper containers and other flammable material from area. Allow fumes to disperse at least 15 minutes before welding or heating.

Do not use a chlorinated solvent in areas where welding will take place.

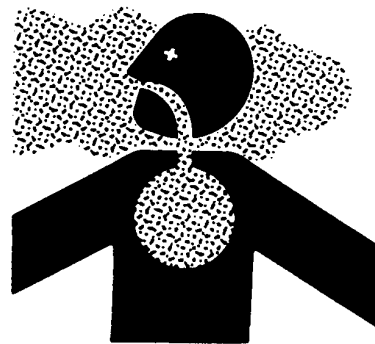

TS220—UN—23AUG88

Do all work in an area that is well ventilated to carry toxic fumes and dust away.

Dispose of paint and solvent properly.

DX,PAINT -19-24JUL02-1/1

Avoid Heating Near Pressurized Fluid Lines

Flammable spray can be generated by heating near pressurized fluid lines, resulting in severe burns to yourself and bystanders. Do not heat by welding, soldering, or using a torch near pressurized fluid lines or other flammable materials. Pressurized lines can accidentally burst when heat goes beyond the immediate flame area.



TS953—UN—15MAY90

DX,TORCH -19-10DEC04-1/1

Keep ROPS Installed Properly

Make certain all parts are reinstalled correctly if the roll-over protective structure (ROPS) is loosened or removed for any reason. Tighten mounting bolts to proper torque.

The protection offered by ROPS will be impaired if ROPS is subjected to structural damage, is involved in an overturn incident, or is in any way altered by welding, bending, drilling, or cutting. A damaged ROPS should be replaced, not reused.

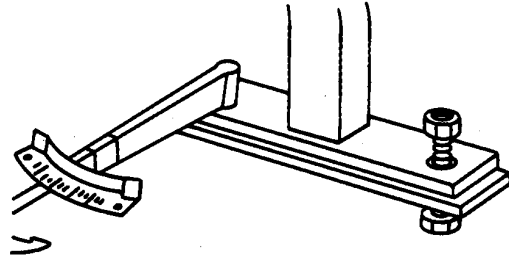

TS212—UN—23AUG88

DX,ROPS3 -19-03MAR93-1/1

Service Tires Safely

Explosive separation of a tire and rim parts can cause serious injury or death.

Do not attempt to mount a tire unless you have the proper equipment and experience to perform the job.

Always maintain the correct tire pressure. Do not inflate the tires above the recommended pressure. Never weld or heat a wheel and tire assembly. The heat can cause an increase in air pressure resulting in a tire explosion. Welding can structurally weaken or deform the wheel.

When inflating tires, use a clip-on chuck and extension hose long enough to allow you to stand to one side and NOT in front of or over the tire assembly. Use a safety cage if available.

Check wheels for low pressure, cuts, bubbles, damaged rims or missing lug bolts and nuts.

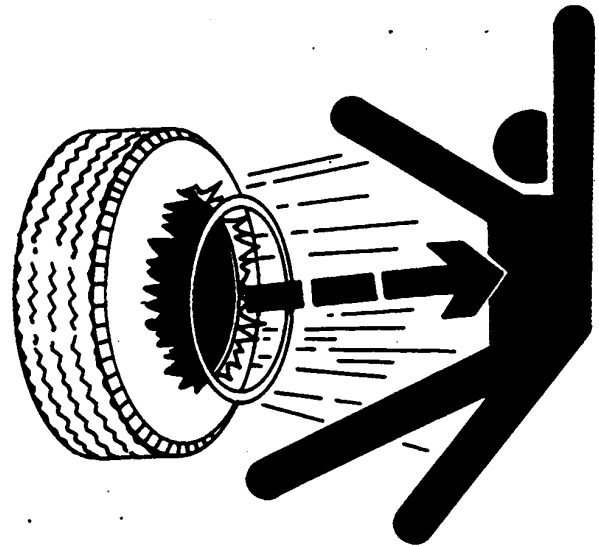

TS211—UN—23AUG88

DX,RIM -19-24AUG90-1/1

Practice Safe Maintenance

Understand service procedure before doing work. Keep area clean and dry.

Never lubricate, service, or adjust machine while it is moving. Keep hands, feet, and clothing from power-driven parts. Disengage all power and operate controls to relieve pressure. Lower equipment to the ground. Stop the engine. Remove the key. Allow machine to cool.

Securely support any machine elements that must be raised for service work.

Keep all parts in good condition and properly installed. Fix damage immediately. Replace worn or broken parts. Remove any buildup of grease, oil, or debris.

On self-propelled equipment, disconnect battery ground cable (-) before making adjustments on electrical systems or welding on machine.

On towed implements, disconnect wiring harnesses from tractor before servicing electrical system components or welding on machine.



TS218 —UN—23AUG88

DX,SERV -19-17FEB99-1/1

Use Proper Tools

Use tools appropriate to the work. Makeshift tools and procedures can create safety hazards.

Use power tools only to loosen threaded parts and fasteners.

For loosening and tightening hardware, use the correct size tools. DO NOT use U.S. measurement tools on metric fasteners. Avoid bodily injury caused by slipping wrenches.

Use only service parts meeting John Deere specifications.



TS779 —UN—08NOV89

DX,REPAIR -19-17FEB99-1/1

Dispose of Waste Properly

Improperly disposing of waste can threaten the environment and ecology. Potentially harmful waste used with John Deere equipment include such items as oil, fuel, coolant, brake fluid, filters, and batteries.

Use leakproof containers when draining fluids. Do not use food or beverage containers that may mislead someone into drinking from them.

Do not pour waste onto the ground, down a drain, or into any water source.

Air conditioning refrigerants escaping into the air can damage the Earth's atmosphere. Government regulations may require a certified air conditioning service center to recover and recycle used air conditioning refrigerants.

Inquire on the proper way to recycle or dispose of waste from your local environmental or recycling center, or from your John Deere dealer.

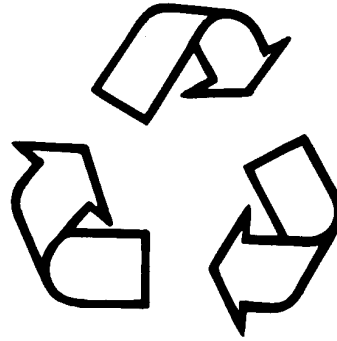

TS1133 —UN—26NOV90

DX,DRAIN -19-03MAR93-1/1

Live With Safety

Before returning machine to customer, make sure machine is functioning properly, especially the safety systems. Install all guards and shields.



TS231 —19—07OCT88

DX,LIVE -19-25SEP92-1/1

Safety Information

410E Backhoe Loader Dimensions

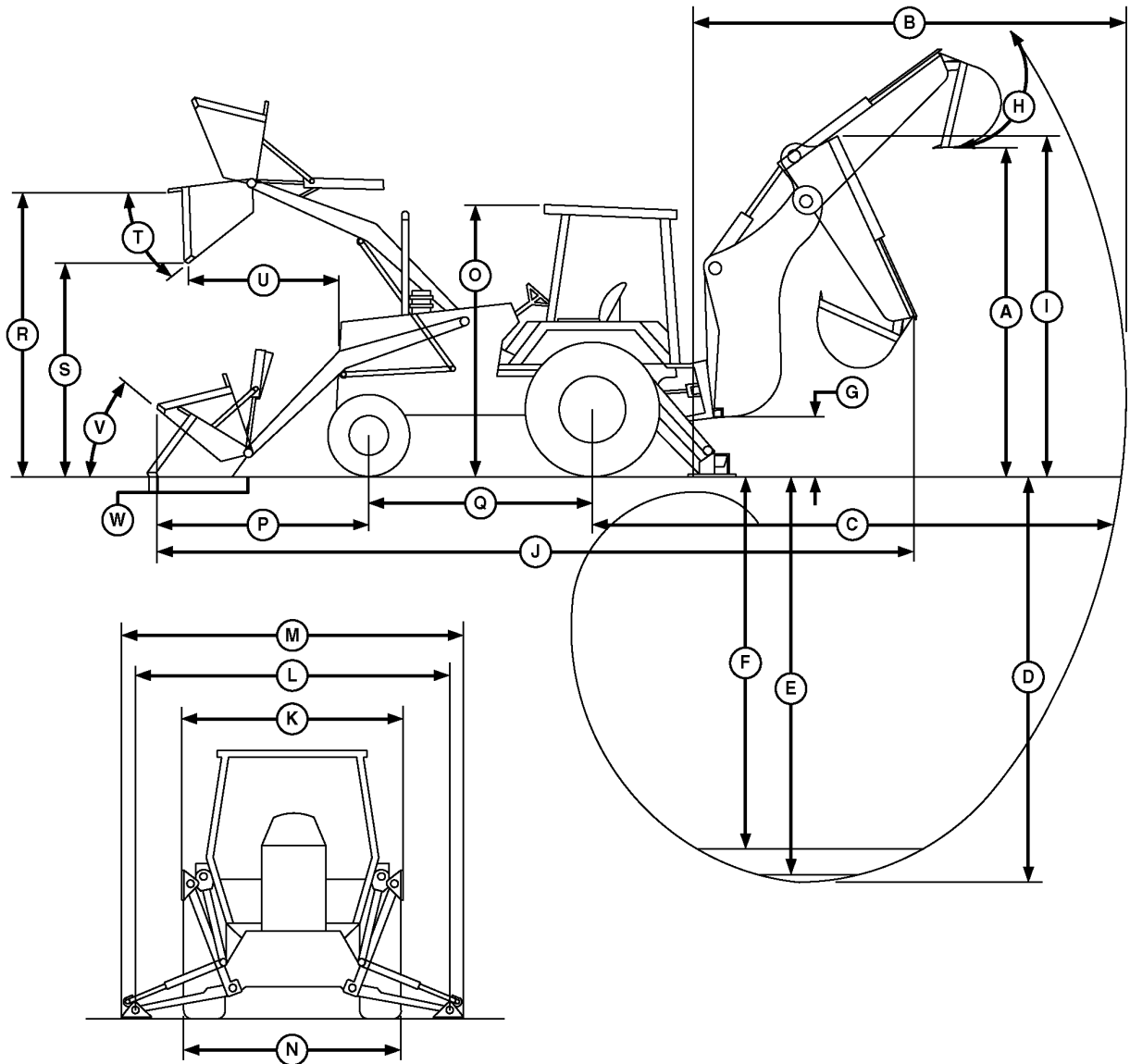

T115805

T115805—UN—11JUN98

NOTE: Specifications and design subject to change without notice. Whenever applicable, specifications are in accordance with SAE Standards unless otherwise noted, these specifications are based on a standard machine with 19.5L-24, 8PR, R4

rear tires; 11L-16, 12PR, F3 front tires; 0.86 m³ (1.12 cu yd) loader bucket; 610 mm (24 in.) backhoe bucket; ROPS/FOPS; full fuel tank and 79 kg (175 lb) operator.

Item	Measurement	Specification
A—Loading Height, Truck Loading Position		
Backhoe w/o Ext. Dipperstick	Height	3.81 m (12 ft 6 in.)

Continued on next page

TX,110,BD2412 -19-10JUN98-1/5

General Specifications

Item	Measurement	Specification
Backhoe w/Ext. Dipperstick Retracted	Height	3.86 m (12 ft 8 in.)
Backhoe w/Ext. Dipperstick Extended	Height	4.72 m (15 ft 6 in.)
B—Reach from Center of Swing Mast		
Backhoe w/o Ext. Dipperstick	Distance	5.99 m (19 ft 8 in.)
Backhoe w/Ext. Dipperstick Retracted	Distance	6.07 m (19 ft 11 in.)
Backhoe w/Ext. Dipperstick Extended	Distance	7.21 m (23 ft 8 in.)
C—Reach From center of Rear Axle		
Backhoe w/o Ext. Dipperstick	Distance	7.11 m (23 ft 4 in.)
Backhoe w/Ext. Dipperstick Retracted	Distance	7.19 m (23 ft 7 in.)
Backhoe w/Ext. Dipperstick Extended	Distance	8.33 m (27 ft 4 in.)
D—Maximum Digging Depth		
Backhoe w/o Ext. Dipperstick	Depth	4.83 m (15 ft 10 in.)
Backhoe w/Ext. Dipperstick Retracted	Depth	4.90 m (16 ft 1 in.)
Backhoe w/Ext. Dipperstick Extended	Depth	6.10 m (20 ft 0 in.)
E—Digging Depth (SAE)—610 mm (2 ft) Flat Bottom		
Backhoe w/o Ext. Dipperstick	Distance	4.78 m (15 ft 8 in.)
Backhoe w/Ext. Dipperstick Retracted	Distance	4.85 m (15 ft 11 in.)
Backhoe w/Ext. Dipperstick Extended	Distance	6.07 m (19 ft 11 in.)
F—Digging Depth (SAE)—2440 mm (8 ft) Flat Bottom		
Backhoe w/o Ext. Dipperstick	Distance	4.45 m (14 ft 7 in.)
Backhoe w/Ext. Dipperstick Retracted	Distance	4.55 m (14 ft 11 in.)
Backhoe w/Ext. Dipperstick Extended	Distance	5.82 m (19 ft 1 in.)
G—Ground Clearance Minimum		
Backhoe w/o Ext. Dipperstick	Clearance	356 mm (14 in.)
Backhoe w/Ext. Dipperstick Retracted	Clearance	356 mm (14 in.)
Backhoe w/Ext. Dipperstick Extended	Clearance	356 mm (14 in.)

Continued on next page

TX,110,BD2412 -19-10JUN98-2/5

General Specifications

Item	Measurement	Specification
H—Bucket Rotation		
Backhoe w/o Ext. Dipperstick	Rotation	190°
Backhoe w/Ext. Dipperstick Retracted	Rotation	190°
Backhoe w/Ext. Dipperstick Extended	Rotation	190°
I—Transport Height		
Backhoe	Height	3.94 m (12 ft 11 in.)
J—Overall Length, Transport		
Backhoe	Length	7.29 m (23 ft 11 in.)
K—Stabilizer Width, Transport		
Backhoe	Width	2.18 m (7 ft 2 in.)
L—Stabilizer Spread, Operating		
Backhoe	Width	3.10 m (10 ft 2 in.)
M—Overall Width, Stabilizer Spread (Less Loader Bucket)		
Backhoe	Width	3.53 m (11 ft 7 in.)
N—Width Over Tires		
Backhoe	Width	2.18 m (7 ft 2 in.)
O—Height to Cab/ROPS Top		
Backhoe	Height	2.82 m (9 ft 3 in.)
P—Front Wheel to Loader Dig Position		
Backhoe	Distance	2.10 m (6 ft 11 in.)
Q—Wheelbase		
Backhoe	Length	2.10 m (6 ft 10 in.)
R—Maximum Height to Loader Bucket Hinge Pin		
Heavy Duty Long Lip 0.86 m ³ (1.12 yd ³)	Height	3.35 m (11 ft 0 in.)
Heavy Duty Long Lip 1.0 m ³ (1.30 yd ³)	Height	3.35 m (11 ft 0 in.)
Multipurpose 0.76 m ³ (1.00 yd ³)	Height	3.35 m (11 ft 0 in.)
S—Dump Clearance, Loader Bucket at 45°		
Heavy Duty Long Lip 0.86 m ³ (1.12 yd ³)	Clearance	2.69 m (8 ft 10 in.)
Heavy Duty Long Lip 1.0 m ³ (1.30 yd ³)	Clearance	2.67 m (8 ft 9 in.)
Multipurpose 0.76 m ³ (1.00 yd ³)	Clearance	2.64 m (8 ft 8 in.)
T—Maximum Loader Bucket Dump Angle		
Heavy Duty Long Lip 0.86 m ³ (1.12 yd ³)	Angle	45°

Continued on next page

TX,110,BD2412 -19-10JUN98-3/5

General Specifications

Item	Measurement	Specification
Heavy Duty Long Lip 1.0 m ³ (1.30 yd ³)	Angle	45°
Multipurpose 0.76 m ³ (1.00 yd ³)	Angle	45°
U—Reach at Full Height, Loader Bucket at 45°		
Heavy Duty Long Lip 0.86 m ³ (1.12 yd ³)	Distance	762 mm (30.0 in.)
Heavy Duty Long Lip 1.0 m ³ (1.30 yd ³)	Distance	787 mm (31.0 in.)
Multipurpose 0.76 m ³ (1.00 yd ³)	Distance	818 mm (32.2 in.)
V—Loader Bucket Rollback at Ground Level		
Heavy Duty Long Lip 0.86 m ³ (1.12 yd ³)	Angle	40°
Heavy Duty Long Lip 1.0 m ³ (1.30 yd ³)	Angle	40°
Multipurpose 0.76 m ³ (1.00 yd ³)	Angle	40°
W—Dig Below Ground—Loader Bucket Level		
Heavy Duty Long Lip 0.86 m ³ (1.12 yd ³)	Depth	170 mm (6.7 in.)
Heavy Duty Long Lip 1.0 m ³ (1.30 yd ³)	Depth	157 mm (6.2 in.)
Multipurpose 0.76 m ³ (1.00 yd ³)	Depth	150 mm (5.9 in.)
Digging Force, Bucket Cylinder		
Backhoe w/o Ext. Dipperstick	Force	65.8 kN (14,801 lb)
Backhoe w/Ext. Dipperstick Retracted	Force	66.7 kN (15,010 lb)
Backhoe w/Ext. Dipperstick Extended	Force	66.7 kN (15,010 lb)
Digging Force, Crowd Cylinder		
Backhoe w/o Ext. Dipperstick	Force	38.9 kN (8741 lb)
Backhoe w/Ext. Dipperstick Retracted	Force	37.6 kN (8446 lb)
Backhoe w/Ext. Dipperstick Extended	Force	26.6 kN (5980 lb)
Swing Arc		
Backhoe w/o Ext. Dipperstick	Rotation	180°
Backhoe w/Ext. Dipperstick Retracted	Rotation	180°
Backhoe w/Ext. Dipperstick Extended	Rotation	180°
Bucket Rotation		
Backhoe w/o Ext. Dipperstick	Rotation	190°

Continued on next page

TX,110,BD2412 -19-10JUN98-4/5

General Specifications

Item	Measurement	Specification
Backhoe w/Ext. Dipperstick Retracted	Rotation	190°
Backhoe w/Ext. Dipperstick Extended	Rotation	190°
Stabilizer Angle Rearward		
Backhoe w/o Ext. Dipperstick	Angle	18°
Backhoe w/Ext. Dipperstick Retracted	Angle	18°
Backhoe w/Ext. Dipperstick Extended	Angle	18°

TX,110,BD2412 -19-10JUN98-5/5

General Specifications

410E Backhoe Loader Specifications

Item	Measurement	Specification
Engine—John Deere 4045T		
Rated Power @ 2200 rpm	Power	SAE gross 73 kW (98 hp)
Rated Power @ 2200 rpm	Power	SAE net 67 kW (90 hp)
Cylinders	Quantity	4
Displacement	Volume	4.52 L (276 in. ³)
Engine Torque Rise	Torque	34%
Maximum Engine Net Torque	Torque	389 N·m (287 lb-ft)
Electrical System	Voltage	12-volt
Alternator	Amperage	65 amps
Alternator with Cab	Amperage	95 amps

Item	Measurement	Specification
Forward Travel Speeds ¹ with Manual Transmission		
Gear 1	Speed	5.8 km/h (3.6 mph)
Gear 2	Speed	9.5 km/h (5.9 mph)
Gear 3	Speed	23.2 km/h (14.4 mph)
Gear 4	Speed	39.3 km/h (24.4 mph)

Item	Measurement	Specification
Reverse Travel Speeds ¹ with Manual Transmission		
Gear 1	Speed	6.4 km/h (4.0 mph)
Gear 2	Speed	10.6 km/h (6.6 mph)
Gear 3	Speed	25.9 km/h (16.1 mph)
Gear 4	Speed	43.8 km/h (27.2 mph)

Item	Measurement	Specification
Forward Travel Speeds ¹ with Powershift Transmission		
Gear 1	Speed	5.8 km/h (3.6 mph)
Gear 2	Speed	9.5 km/h (5.9 mph)
Gear 3	Speed	23.2 km/h (14.4 mph)
Gear 4	Speed	39.3 km/h (24.4 mph)

NOTE: With powershift transmission, third and fourth gear speeds are the same in reverse.

Item	Measurement	Specification
Reverse Travel Speeds ¹ with Powershift Transmission		
Gear 1	Speed	6.4 km/h (4.0 mph)
Gear 2	Speed	10.6 km/h (6.0 mph)

Continued on next page

TX,115,BG331 -19-30SEP97-1/2

General Specifications

Item	Measurement	Specification
Gear 3	Speed	25.9 km/h (16.1 mph)
Gear 4	Speed	43.8 km/h (27.2 mph)
Item	Measurement	Specification
Steering: Hydrostatic Power		
Non-Powered Axle Curb Turning Radius—Brakes Applied	Radius	3.56 m (11 ft 8 in.)
Non-Powered Axle Curb Turning Radius—Without Brakes	Radius	4.04 m (13 ft 3 in.)
Non-Powered Axle Bucket Clearance Circle—Brakes Applied	Radius	9.65 m (31 ft 8 in.)
Non-Powered Axle Bucket Clearance Circle—Without Brakes	Radius	10.59 m (34 ft 10 in.)
Non-Powered Axle Steering Wheel Turns—Stop to Stop	Quantity	2.3—3.0 turns
Powered Axle (MFWD) Curb Turning Radius—Brakes Applied	Radius	3.56 m (11 ft 8 in.)
Powered Axle (MFWD) Curb Turning Radius—Without Brakes	Radius	4.04 m (13 ft 3 in.)
Powered Axle Bucket Clearance Circle—Brakes Applied	Radius	9.65 m (31 ft 8 in.)
Powered Axle Bucket Clearance Circle—Without Brakes	Radius	10.59 m (34 ft 9 in.)
Non-Powered Axle Steering Wheel Turns—Stop to Stop	Quantity	2.5 turns
Item	Measurement	Specification
Hydraulic System: Closed Center		
Main Pressure Relief Setting	Pressure	25 000 kPa (3625 psi)
Flow @ 2200 rpm, Backhoe	Flow Rate	159 L/min. (42 gpm)
Flow @ 2200 rpm, Loader	Flow Rate	159 L/min. (42 gpm)

¹With standard 19.5L-24 rear tires.

General Specifications

Other Information—410E Backhoe Loader

Hydraulic system:

- Axial piston pump
- 10 micron replaceable element return oil filter

Final drives:

- Heavy-duty inboard mounted planetary
- Evenly distributes axle shock loads over three oil cooled gears

Brakes:

- Hydraulic wet disk
- Mounted inboard
- Self-adjusting
- Self-equalizing

Park brake:

- Independent system
- Spring applied
- Hydraulically released
- Controlled by an electric switch on the side console

Transmission:

- 4-speed helical gear

- Synchronized collar shift transmission with hydraulic reverser
- Torque converter 280 mm (11 in.) with 2.12:1 stall ratio

Lubrication:

- Pressure system with spin-on filter
- Air cleaner
- Dual stage dry, with element and precleaner

Tires:

- Front w/o MFWD—14.5/75-16.1, 10PR F3
- Front w/o MFWD—11L-16, 12PR F3
- Front with MFWD—12.5/80, 10PR
- Rear w/o MFWD—19.5L-24, 10PR R4
- Rear w/o MFWD—21L-24, 10PR R4
- Rear with MFWD—19.5L-24, 10PR R4
- Rear with MFWD—21L-24, 10PR R4

Operator Control:

- Backhoe w/o Ext. Dipperstick
 - Two Levers
- Backhoe w/Ext. Dipperstick Retracted
 - Right Foot Treadle
- Backhoe w/Ext. Dipperstick Retracted
 - Right Foot Treadle

CED,OUO1032,1006 -19-09JUN98-1/1

410E Backhoe Loader Weight

Item	Measurement	Specification
Transporting		
SAE Operating Weight with ROPS	Weight	5806 kg (12,800 lb)
Cab Added	Weight	263 kg (580 lb)
MFWD with Tires Added	Weight	168 kg (370 lb)
Extendible Dipperstick	Weight	200 kg (440 lb)
Optional Front Counterweight	Weight	181 kg (400 lb)
Optional Front Counterweight	Weight	295 kg (650 lb)

TX,110,BD2420 -19-06DEC96-1/1

General Specifications

410E Backhoe and Loader Buckets

Loader:	Width		Heaped Capacity		Weight	
	mm	(In.)	m ³	(Cu Yd)	kg	lb
Heavy duty long lip	2340	(92)	1.00	(1.30)	476	(1050)
	2340	(92)	1.15	(1.50)	540	(1190)
Multipurpose	2340	(92)	0.96	(1.25)	703	(1550)

Backhoe:	Width		Heaped Capacity		Weight	
	mm	(In.)	m ³	(Cu Ft)	kg	(lb)
Standard duty	610	(24)	0.21	(7.5)	159	(350)
Heavy duty with lift loops	305	(12)	0.09	(3.3)	134	(295)
	457	(18)	0.14	(5.1)	152	(335)
	610	(24)	0.21	(7.5)	181	(400)
	762	(30)	0.25	(8.8)	191	(420)
	914	(36)	0.35	(12.5)	231	(510)
Extra Heavy Duty	457	(18)	0.14	(5.1)	164	(362)
	610	(24)	0.21	(7.5)	193	(425)
	610	(24)	0.25	(8.8)	206	(455)
	762	(30)	0.28	(10.0)	215	(475)
Ditch cleaning	914	(36)	0.35	(12.5)	231	(510)

TX,110,BD2212 -19-15JUN98-1/1

410E Backhoe Loader Drain and Refill Capacities

Item	Measurement	Specification
Engine Coolant	Capacity	16 L (17 qt)
Engine Oil (including filter)	Capacity	12.8 L (13.5 qt)
Torque Converter and Transmission System	Capacity	14 L (15 qt)
Rear Axle (S.N. —851673)	Capacity	13 L (14 qt)
Rear Axle (S.N. 851674—)	Capacity	16 L (17 qt)
MFWD Front Axle Housing	Capacity	6.5 L (7 qt)
MFWD Front Wheel Planetary Housing (each)	Capacity	1 L (1.1 qt)
Fuel Tank	Capacity	136 L (36 gal)
Hydraulic System Reservoir	Capacity	37 L (39 qt)

TX,115,BG332 -19-01NOV99-1/1

410E Backhoe Loader Lifting Capacities—Standard Dipperstick

Lifting capacity ratings are made with bucket hinge pin, loader bucket and stabilizers on firm, level ground. Lift capacities are hydraulically limited. Lifting capacities are 87 percent of the maximum lift over any point on the swing arc and do not exceed 75 percent of the tipping load. Angle between boom and ground is 65 degrees. Machine is equipped with 610 mm (24 in.) standard bucket, standard or extendible dipperstick, and standard equipment.

NOTE: Loader bucket on ground significantly improves side stability, therefore improving lift capacity to the side. Lift capacity over the rear is not affected.

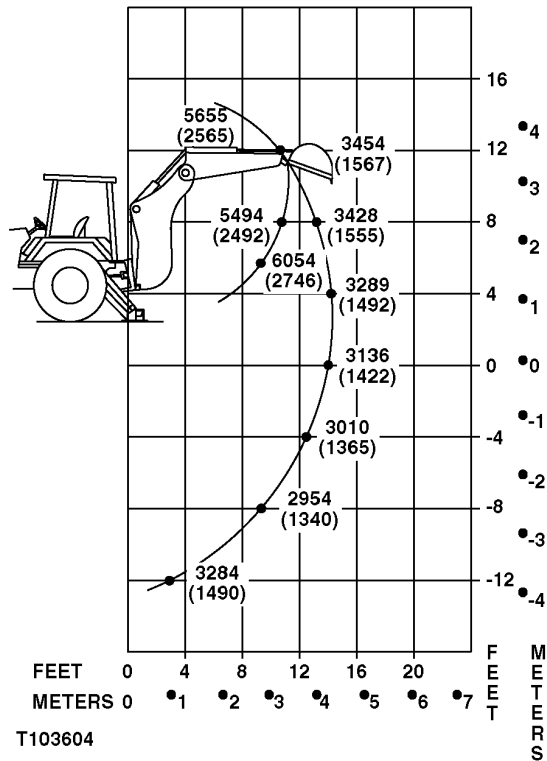

Lift Capacity, Backhoe with Standard Dipperstick
Based on SAE J31 (Except with Loader Bucket on Ground)

T105558—19—04DEC96

T103604

TX,110,BD2416 -19-06DEC96-1/1

410E Backhoe Loader Lifting Capacities—Extendible Dipperstick (Retracted)

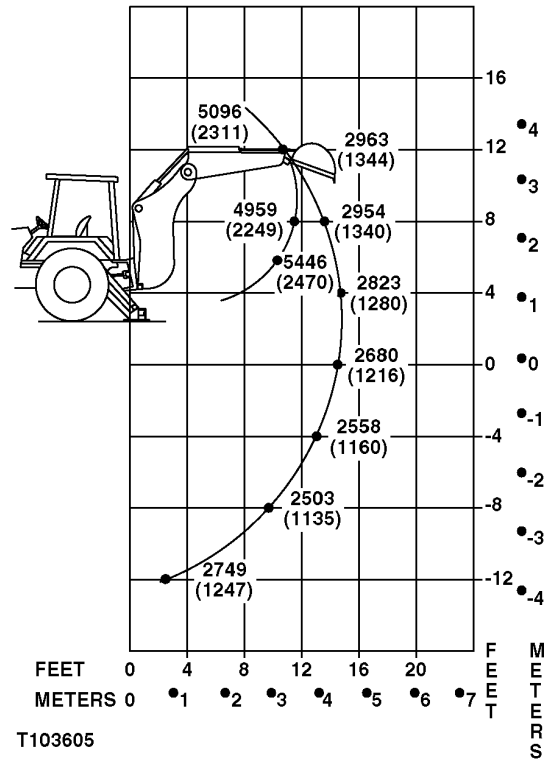

T103605

*Lift Capacity, Backhoe with Extendible Dipperstick, Retracted
Based on SAE J31 (Except with Loader Bucket on Ground)*

T105559 -19-04DEC96

TX,110,BD2417 -19-06DEC96-1/1

410E Backhoe Loader Lifting Capacities—Extendible Dipperstick (Extended)

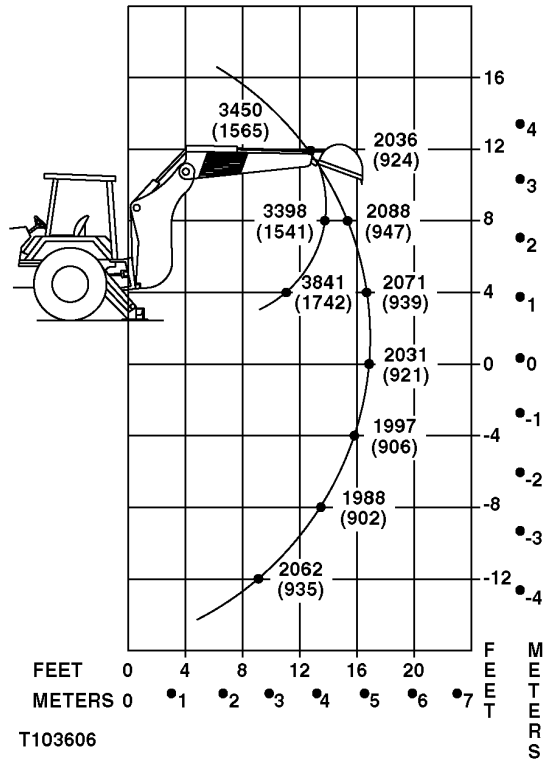

T103606

Lift Capacity, Backhoe with Extendible Dipperstick, Retracted Based on SAE J31 (Except with Loader Bucket on Ground)

T105560—19—04DEC96

TX,110,BD2418 -19-06DEC96-1/1