

Product: John Deere 3215 3215A 3215B 3225B 3235 3235A 3235B Lightweight Fairway Mower Service Repair Technical M

Full Download: [https://www.bobmanualstore.com/downloads/john-deere-3215-3215a-3215b-3225b-3235-3235a-3235b-lightweight-fairway-mower-se](https://www.bobmanualstore.com/downloads/john-deere-3215-3215a-3215b-3225b-3235-3235a-3235b-lightweight-fairway-mower-service-repair-technical-manual/)

[5a-3215b-3225b-3235-3235a-3235b-lightweight-fairway-mower-se
vice-repair-technical-manual/](https://www.bobmanualstore.com/downloads/john-deere-3215-3215a-3215b-3225b-3235-3235a-3235b-lightweight-fairway-mower-service-repair-technical-manual/)

JOHN DEERE
WORLDWIDE COMMERCIAL & CONSUMER
EQUIPMENT DIVISION

Lightweight Fairway Mower
3215, 3215A, 3215B, 3225B, 3235, 3235A
and 3235B

TM1534 FEB03

TECHNICAL MANUAL



JOHN DEERE

North American Version
Litho in U.S.A.

Sample manual. Download All 492 pages at:

[https://www.bobmanualstore.com/downloads/john-deere-3215-3215a-3215b-3225b-3235-3235a-3235b-lightweight-fairway-mov](https://www.bobmanualstore.com/downloads/john-deere-3215-3215a-3215b-3225b-3235-3235a-3235b-lightweight-fairway-mower-service-repair-technical-manual/)

Product: John Deere 3215 3215A 3215B 3225B 3235 3235A 3235B Lightweight Fairway Mower Service Repair Technical M

Full Download: [https://www.bobmanualstore.com/downloads/john-deere-3215-3215a-3215b-3225b-3235-3235a-3235b-lightweight-fairway-mower-se](https://www.bobmanualstore.com/downloads/john-deere-3215-3215a-3215b-3225b-3235-3235a-3235b-lightweight-fairway-mower-service-repair-technical-manual/)

[vice-repair-technical-manual/](https://www.bobmanualstore.com/downloads/john-deere-3215-3215a-3215b-3225b-3235-3235a-3235b-lightweight-fairway-mower-service-repair-technical-manual/)

Sample manual. Download All 492 pages at:

[https://www.bobmanualstore.com/downloads/john-deere-3215-3215a-3215b-3225b-3235-3235a-3235b-lightweight-fairway-mov](https://www.bobmanualstore.com/downloads/john-deere-3215-3215a-3215b-3225b-3235-3235a-3235b-lightweight-fairway-mower-service-repair-technical-manual/)

INTRODUCTION

Manual Description

This technical manual is written for an experienced technician and contains sections that are specifically for this product. It is a part of a total product support program.

The manual is organized so that all the information on a particular system is kept together. The order of grouping is as follows:

- Table of Contents
- Specifications and Information
- Identification Numbers
- Tools and Materials
- Component Location
- Schematics and Harnesses
- Theory of Operation
- Operation and Diagnostics
- Diagnostics
- Tests and Adjustments
- Repair
- Other

NOTE: Depending on the particular section or system being covered, not all of the above groups may be used.

The bleed tabs for the pages of each section will align with the sections listed on this page. Page numbering is consecutive from the beginning of the Safety section through the last section.

We appreciate your input on this manual. If you find any errors or want to comment on the layout of the manual please contact us.

Safety

Specifications and Information

Engine

Electrical

Power Train

Hydraulics

Steering

Brakes

Attachments

All information, illustrations and specifications in this manual are based on the latest information at the time of publication. The right is reserved to make changes at any time without notice.

COPYRIGHT© 2003
Deere & Co.
John Deere Worldwide Commercial and
Consumer Equipment Division
All rights reserved
Previous Editions
COPYRIGHT©

INTRODUCTION

SAFETY

Be Prepared For Emergencies

Recognize Safety Information

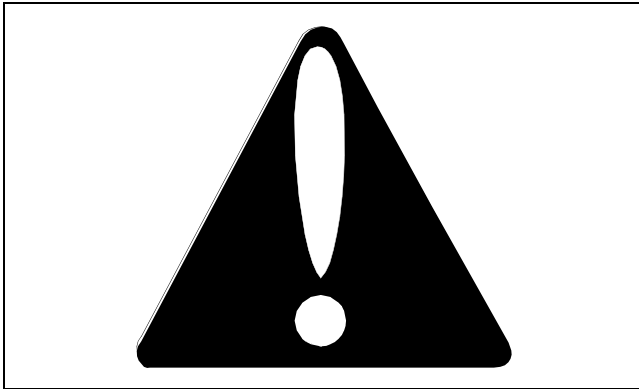

MIF

This is the safety-alert symbol. When you see this symbol on your machine or in this manual, be alert to the potential for personal injury.

Follow recommended precautions and safe servicing practices.

Understand Signal Words

A signal word - DANGER, WARNING, or CAUTION - is used with the safety-alert symbol. DANGER identifies the most serious hazards.

DANGER or WARNING safety signs are located near specific hazards. General precautions are listed on CAUTION safety signs. CAUTION also calls attention to safety messages in this manual.

Replace Safety Signs

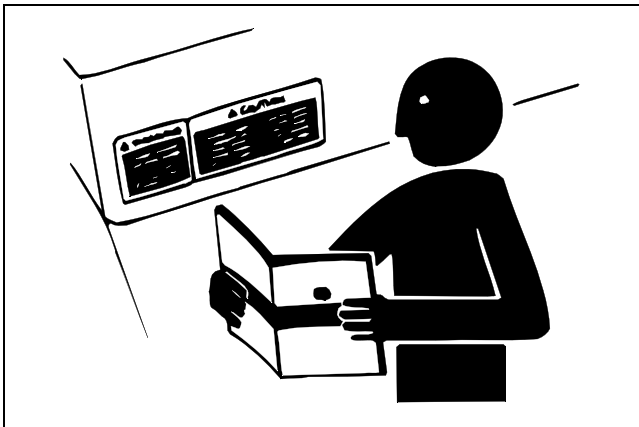

MIF

Replace missing or damaged safety signs. See the machine operator's manual for correct safety sign placement.

Handle Fluids Safely - Avoid Fires

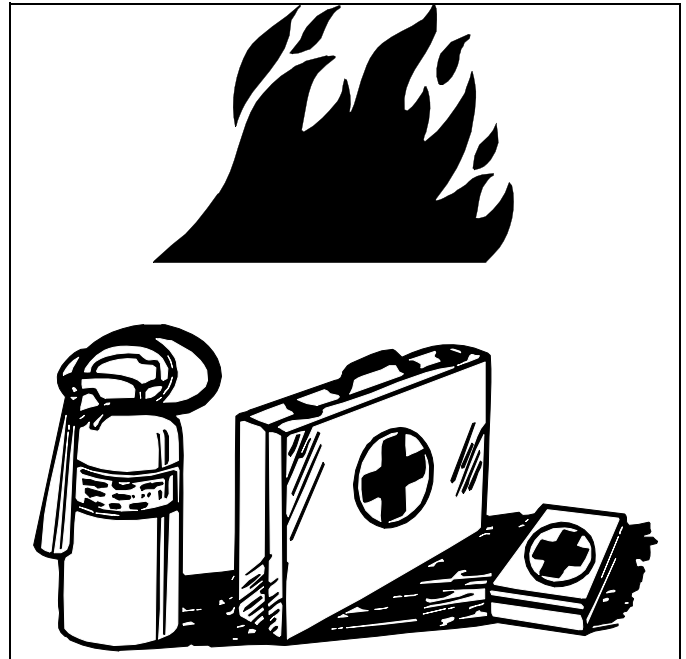

MIF

When you work around fuel, do not smoke or work near heaters or other fire hazards.

Store flammable fluids away from fire hazards. Do not incinerate or puncture pressurized containers.

Make sure machine is clean of trash, grease, and debris.

Do not store oily rags; they can ignite and burn spontaneously.

Be prepared if a fire starts.

Keep a first aid kit and fire extinguisher handy.

Keep emergency numbers for doctors, ambulance service, hospital, and fire department near your telephone.

Use Care in Handling and Servicing Batteries

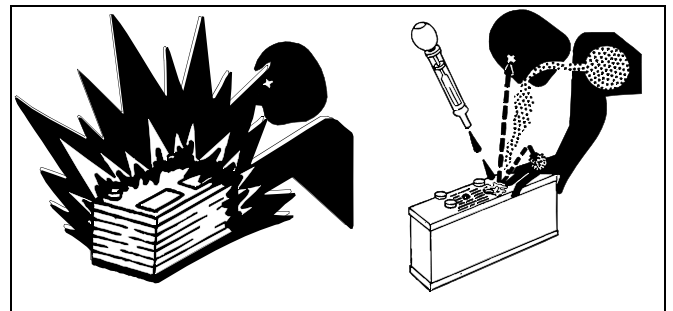

MIF

Prevent Battery Explosions

- Keep sparks, lighted matches, and open flame away from the top of battery. Battery gas can explode.

SAFETY

- Never check battery charge by placing a metal object across the posts. Use a voltmeter or hydrometer.
- Do not charge a frozen battery; it may explode. Warm battery to 16°C (60°F).

Prevent Acid Burns

- Sulfuric acid in battery electrolyte is poisonous. It is strong enough to burn skin, eat holes in clothing, and cause blindness if splashed into eyes.

Avoid acid burns by:

1. Filling batteries in a well-ventilated area.
2. Wearing eye protection and rubber gloves.
3. Avoiding breathing fumes when electrolyte is added.
4. Avoiding spilling or dripping electrolyte.
5. Using proper jump start procedure.

If you spill acid on yourself:

1. Flush your skin with water.
2. Apply baking soda or lime to help neutralize the acid.
3. Flush your eyes with water for 10-15 minutes.
4. Get medical attention immediately.

If acid is swallowed:

1. Drink large amounts of water or milk.
2. Then drink milk of magnesia, beaten eggs, or vegetable oil.
3. Get medical attention immediately.

Use Care Around High-Pressure Fluid Lines

Avoid High-Pressure Fluids



MIF

Escaping fluid under pressure can penetrate the skin causing serious injury.

Avoid injury from escaping fluid under pressure by stopping the engine and relieving pressure in the system before disconnecting or connecting hydraulic or other lines. Tighten all connections before applying pressure.

Search for leaks with a piece of cardboard. Protect hands and body from high-pressure fluids.

If an accident occurs, see a doctor immediately. Any fluid injected into the skin must be surgically removed within a few hours or gangrene may result. Doctors unfamiliar with this type of injury should reference a knowledgeable medical source. Such information is available from Deere & Company Medical Department in Moline, Illinois, U.S.A.

Avoid Heating Near Pressurized Fluid Lines



MIF

Flammable spray can be generated by heating near pressurized fluid lines, resulting in severe burns to yourself and bystanders. Do not heat by welding, soldering, or using a torch near pressurized fluid lines or other flammable materials. Pressurized lines can be accidentally cut when heat goes beyond the immediate flame area.

Use Safe Service Procedures

Wear Protective Clothing

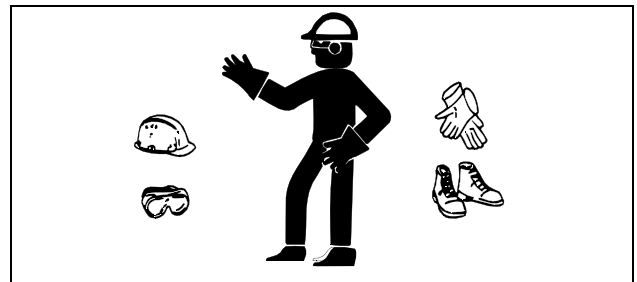

MIF

Wear close-fitting clothing and safety equipment appropriate to the job.

Prolonged exposure to loud noise can cause impairment or loss of hearing. Wear a suitable hearing protective device such as earmuffs or earplugs to protect against objectionable or uncomfortable loud noises.

Operating equipment safely requires the full attention of the operator. Do not wear radio or music headphones while operating machine.

SAFETY

Service Machines Safely

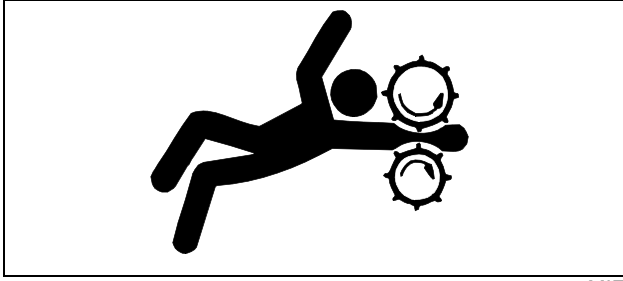

MIF

Tie long hair behind your head. Do not wear a necktie, scarf, loose clothing, or necklace when you work near machine tools or moving parts. If these items were to get caught, severe injury could result.

Remove rings and other jewelry to prevent electrical shorts and entanglement in moving parts.

Use Proper Tools

Use tools appropriate to the work. Makeshift tools and procedures can create safety hazards. Use power tools only to loosen threaded parts and fasteners. For loosening and tightening hardware, use the correct size tools. **DO NOT** use U.S. measurement tools on metric fasteners. Avoid bodily injury caused by slipping wrenches. Use only service parts meeting John Deere specifications.

Park Machine Safely

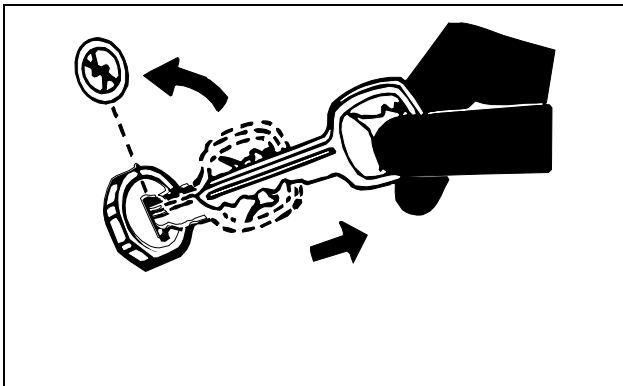

MIF

Before working on the machine:

1. Lower all equipment to the ground.
2. Stop the engine and remove the key.
3. Disconnect the battery ground strap.
4. Hang a "DO NOT OPERATE" tag in operator station.

Support Machine Properly and Use Proper Lifting Equipment

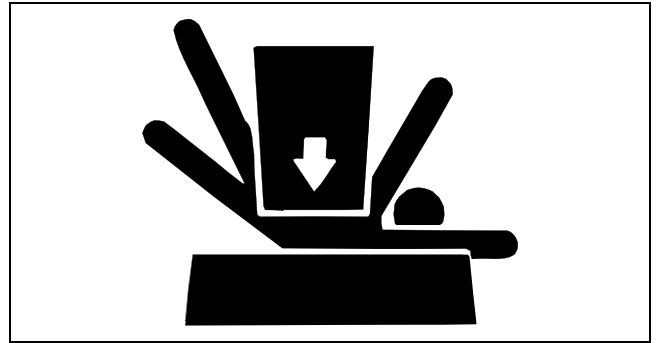

MIF

If you must work on a lifted machine or attachment, securely support the machine or attachment.

Do not support the machine on cinder blocks, hollow tiles, or props that may crumble under continuous load. Do not work under a machine that is supported solely by a jack. Follow recommended procedures in this manual.

Lifting heavy components incorrectly can cause severe injury or machine damage. Follow recommended procedure for removal and installation of components in the manual.

Work in Clean Area

Before starting a job:

1. Clean work area and machine.
2. Make sure you have all necessary tools to do your job.
3. Have the right parts on hand.
4. Read all instructions thoroughly; do not attempt shortcuts.

Using High-Pressure Washers

Directing pressurized water at electronic/electrical components or connectors, bearings, hydraulic seals, fuel injection pumps or other sensitive parts and components may cause product malfunctions. Reduce pressure and spray at a 45 to 90 degree angle.

Illuminate Work Area Safely

Illuminate your work area adequately but safely. Use a portable safety light for working inside or under the machine. Make sure the bulb is enclosed by a wire cage. The hot filament of an accidentally broken bulb can ignite spilled fuel or oil.

Work in Ventilated Area

SAFETY

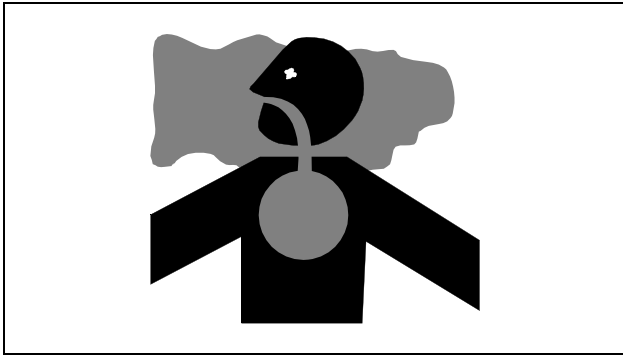

MIF

Engine exhaust fumes can cause sickness or death. If it is necessary to run an engine in an enclosed area, remove the exhaust fumes from the area with an exhaust pipe extension.

If you do not have an exhaust pipe extension, open the doors and get outside air into the area.

WARNING: California Proposition 65 Warning

Diesel engine exhaust and some of its constituents are known to the State of California to cause cancer, birth defects, and other reproductive harm.

Gasoline engine exhaust from this product contains chemicals known to the State of California to cause cancer, birth defects, or other reproductive harm.

Remove Paint Before Welding or Heating

Avoid potentially toxic fumes and dust. Hazardous fumes can be generated when paint is heated by welding, soldering, or using a torch. Do all work outside or in a well ventilated area. Dispose of paint and solvent properly. Remove paint before welding or heating: If you sand or grind paint, avoid breathing the dust. Wear an approved respirator. If you use solvent or paint stripper, remove stripper with soap and water before welding. Remove solvent or paint stripper containers and other flammable material from area. Allow fumes to disperse at least 15 minutes before welding or heating.

Avoid Harmful Asbestos Dust

Avoid breathing dust that may be generated when handling components containing asbestos fibers. Inhaled asbestos fibers may cause lung cancer.

Components in products that may contain asbestos fibers are brake pads, brake band and lining assemblies, clutch plates, and some gaskets. The asbestos used in these components is usually found in a resin or sealed in some way. Normal handling is not hazardous as long as airborne dust containing asbestos is not generated.

Avoid creating dust. Never use compressed air for cleaning. Avoid brushing or grinding material containing asbestos. When servicing, wear an approved respirator. A special

vacuum cleaner is recommended to clean asbestos. If not available, apply a mist of oil or water on the material containing asbestos. Keep bystanders away from the area.

Service Tires Safely



MIF

Explosive separation of a tire and rim parts can cause serious injury or death.

Do not attempt to mount a tire unless you have the proper equipment and experience to perform the job. Always maintain the correct tire pressure. Do not inflate the tires above the recommended pressure. Never weld or heat a wheel and tire assembly. The heat can cause an increase in air pressure resulting in a tire explosion. Welding can structurally weaken or deform the wheel.

When inflating tires, use a clip-on chuck and extension hose long enough to allow you to stand to one side and NOT in front of or over the tire assembly. Use a safety cage if available.

Check wheels for low pressure, cuts, bubbles, damaged rims or missing lug bolts and nuts.

Avoid Injury from Rotating Blades and Drive Shafts

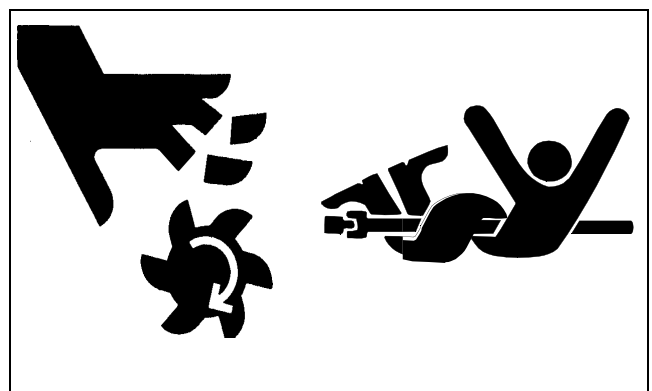

MIF

Keep hands and feet away while machine is running. Shut off power to service, lubricate or remove mower blades or drive shafts.

SAFETY

Service Cooling System Safety

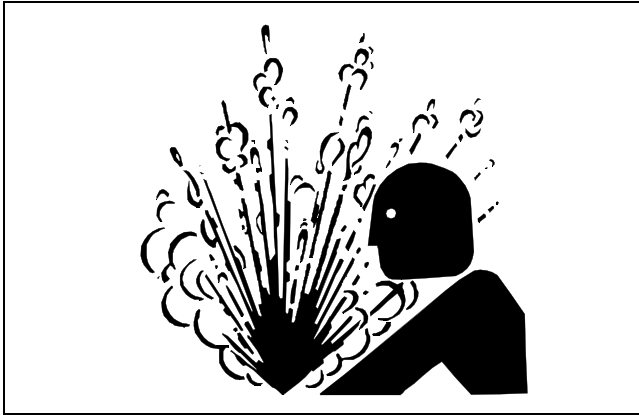

MIF

Explosive release of fluids from pressurized cooling system can cause serious burns.

Shut off machine. Only remove filler cap when cool enough to touch with bare hands. Slowly loosen the cap to first stop to relieve the pressure before removing completely.

Handle Chemical Products Safely

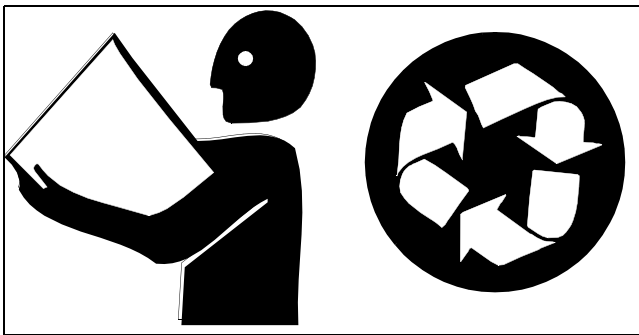

MIF

Direct exposure to hazardous chemicals can cause serious injury. Potentially hazardous chemicals used with John Deere equipment include such items as lubricants, coolants, paints, and adhesives.

A Material Safety Data Sheet (MSDS) provides specific details on chemical products: physical and health hazards, safety procedures, and emergency response techniques. Check the MSDS before you start any job using a hazardous chemical. That way you will know exactly what the risks are and how to do the job safely. Then follow procedures and recommended equipment.

Dispose of Waste Properly

Improperly disposing of waste can threaten the environment and ecology. Potentially harmful waste used with John Deere equipment includes such items as oil, fuel, coolant, brake fluid, filters, and batteries. Use leakproof containers when draining fluids. Do not use food or beverage containers that may mislead someone into

drinking from them. Do not pour waste onto the ground, down a drain, or into any water source. Inquire on the proper way to recycle or dispose of waste from your local environmental or recycling center, or from your John Deere dealer.

LIVE WITH SAFETY



MIF

Before returning machine to customer, make sure machine is functioning properly, especially the safety systems. Install all guards and shields.

SAFETY

SPECIFICATIONS AND INFORMATION TABLE OF CONTENTS

Table of Contents

General Information.....	9
Metric Fastener Torque Values	9
Metric Fastener Torque Values - Grade 7....	10
Inch Fastener Torque Values	11
Face Seal Fittings with Inch Stud Ends Torque	12
Face Seal Fittings with Metric Stud Ends Torque	13
O-Ring Face Seal Fittings	14
O-Ring Boss Fittings	14
Diesel Fuel - North America	15
Diesel Fuel - Europe.....	15
Diesel Fuel Lubricity	15
Diesel Fuel Storage.....	16
4-Cycle Diesel Engine Oil - North America ..	16
4-Cycle Diesel Engine Oil - Europe.....	17
Break-In Diesel Engine Oil - North America .	18
Break-In Diesel Engine Oil - Europe	19
Hydrostatic Transmission and Hydraulic Oil	20
Biodegradable Oil.....	20
Anti-Corrosion Grease.....	21
Grease - North America	22
Grease - Europe.....	23
Alternative Lubricants.....	23
Synthetic Lubricants	23
Lubricant Storage	23
Mixing of Lubricants	23
Oil Filters	24
Diesel Engine Coolant - North America.....	24
Diesel Engine Coolant Drain Interval - North America	25
Diesel Engine Coolant - Europe	25
Diesel Engine Coolant Drain Interval - Europe.....	25
Identification Numbers.....	26
Serial Number Location.....	26
Mower Identification Number.....	26
Engine Serial Number	26
Cutting Unit Serial Numbers.....	26

SPECIFICATIONS AND INFORMATION TABLE OF CONTENTS

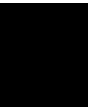

SPECIFICATIONS AND INFORMATION GENERAL INFORMATION

General Information

Metric Fastener Torque Values

Property Class and Head Markings				
Property Class and Nut Markings				

TS1163

SIZE	Class 4.8				Class 8.8 or 9.8				Class 10.9				Class 12.9			
	Lubricated ^a		Dry ^a		Lubricated ^a		Dry ^a		Lubricated ^a		Dry ^a		Lubricated ^a		Dry ^a	
	N•m	lb-ft	N•m	lb-ft	N•m	lb-ft	N•m	lb-ft	N•m	lb-ft	N•m	lb-ft	N•m	lb-ft	N•m	lb-ft
M6	4.8	3.5	6	4.5	9	6.5	11	8.5	13	9.5	17	12	15	11.5	19	14.5
M8	12	8.5	15	11	22	16	28	20	32	24	40	30	37	28	47	35
M10	23	17	29	21	43	32	55	40	63	47	80	60	75	55	95	70
M12	40	29	50	37	75	55	95	70	110	80	140	105	130	95	165	120
M14	63	47	80	60	120	88	150	110	175	130	225	165	205	150	260	109
M16	100	73	125	92	190	140	240	175	275	200	350	225	320	240	400	300
M18	135	100	175	125	260	195	330	250	375	275	475	350	440	325	560	410
M20	190	140	240	180	375	275	475	350	530	400	675	500	625	460	800	580
M22	260	190	330	250	510	375	650	475	725	540	925	675	850	625	1075	800
M24	330	250	425	310	650	475	825	600	925	675	1150	850	1075	800	1350	1000
M27	490	360	625	450	950	700	1200	875	1350	1000	1700	1250	1600	1150	2000	1500
M30	675	490	850	625	1300	950	1650	1200	1850	1350	2300	1700	2150	1600	2700	2000
M33	900	675	1150	850	1750	1300	2200	1650	2500	1850	3150	2350	2900	2150	3700	2750
M36	1150	850	1450	1075	2250	1650	2850	2100	3200	2350	4050	3000	3750	2750	4750	3500

DO NOT use these hand torque values if a different torque value or tightening procedure is given for a specific application. Torque values listed are for general use only and include a ±10% variance factor. Check tightness of fasteners periodically. DO NOT use air-powered wrenches.

Shear bolts are designed to fail under predetermined loads. Always replace shear bolts with identical grade.

Fasteners should be replaced with the same class. Make sure fastener threads are clean and that you properly start thread engagement. This will prevent them from failing when tightening.

When bolt and nut combination fasteners are used, torque values should be applied to the NUT instead of the bolt head.

Tighten toothed or serrated-type lock nuts to the full torque value.

a "Lubricated" means coated with a lubricant such as engine oil, or fasteners with phosphate and oil coatings. "Dry" means plain or zinc plated (yellow dichromate-Specification JDS117) without any lubrication.

Reference: JDS-200.





SPECIFICATIONS AND INFORMATION GENERAL INFORMATION

Metric Fastener Torque Values - Grade 7

Size	Steel or Gray Iron Torque		Aluminum Torque	
	N•m	lb-ft	N•m	lb-ft
M6	11	8	8	6
M8	24	18	19	14
M10	52	38	41	30
M12	88	65	70	52
M14	138	102	111	82
M16	224	165	179	132

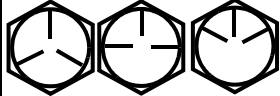
SPECIFICATIONS AND INFORMATION GENERAL INFORMATION

Inch Fastener Torque Values

SAE Grade and Head Markings	1 or 2 ^b No Marks 	5 5.1 5.2 	8 8.2 
SAE Grade and Nut Markings	2 No Marks 	5 	8 

TS1162

SIZE	Grade 1		Grade 2 ^b		Grade 5, 5.1 or 5.2		Grade 8 or 8.2									
	Lubricated ^a	Dry ^a	Lubricated ^a	Dry ^a	Lubricated ^a	Dry ^a	Lubricated ^a	Dry ^a								
	N•m	lb-ft	N•m	lb-ft	N•m	lb-ft	N•m	lb-ft								
1/4	3.7	2.8	4.7	3.5	6	4.5	7.5	5.5	9.5	7	12	9	13.5	10	17	12.5
5/16	7.7	5.5	10	7	12	9	15	11	20	15	25	18	28	21	35	26
3/8	14	10	17	13	22	16	27	20	35	26	44	33	50	36	63	46
7/16	22	16	28	20	35	26	44	32	55	41	70	52	80	58	100	75
1/2	33	25	42	31	53	39	67	50	85	63	110	80	120	90	150	115
9/16	48	36	60	45	75	56	95	70	125	90	155	115	175	130	225	160
5/8	67	50	85	62	105	78	135	100	170	125	215	160	215	160	300	225
3/4	120	87	150	110	190	140	240	175	300	225	375	280	425	310	550	400
7/8	190	140	240	175	190	140	240	175	490	360	625	450	700	500	875	650
1	290	210	360	270	290	210	360	270	725	540	925	675	1050	750	1300	975
1-1/8	470	300	510	375	470	300	510	375	900	675	1150	850	1450	1075	1850	1350
1-1/4	570	425	725	530	570	425	725	530	1300	950	1650	1200	2050	1500	2600	1950
1-3/8	750	550	950	700	750	550	950	700	1700	1250	2150	1550	2700	2000	3400	2550
1-1/2	1000	725	1250	925	990	725	1250	930	2250	1650	2850	2100	3600	2650	4550	3350

DO NOT use these hand torque values if a different torque value or tightening procedure is given for a specific application. Torque values listed are for general use only and include a ±10% variance factor. Check tightness of fasteners periodically. DO NOT use air-powered wrenches.

Shear bolts are designed to fail under predetermined loads. Always replace shear bolts with identical grade.

Fasteners should be replaced with the same grade. Make sure fastener threads are clean and that you properly start thread engagement. This will prevent them from failing when tightening.

When bolt and nut combination fasteners are used, torque

values should be applied to the NUT instead of bolt head.

Tighten toothed or serrated-type lock nuts to full torque value.

a "Lubricated" means coated with a lubricant such as engine oil, or fasteners with phosphate and oil coatings. "Dry" means plain or zinc plated (yellow dichromate-Specification JDS117) without any lubrication.

b "Grade 2" applies for hex cap screws (not hex bolts) up to 152-mm (6-in.) long. "Grade 1" applies for hex cap screws over 152-mm (6-in.) long, and for all other types of bolts and screws of any length.

Reference: JDS-G200.

SPECIFICATIONS AND INFORMATION GENERAL INFORMATION

Face Seal Fittings with Inch Stud Ends Torque

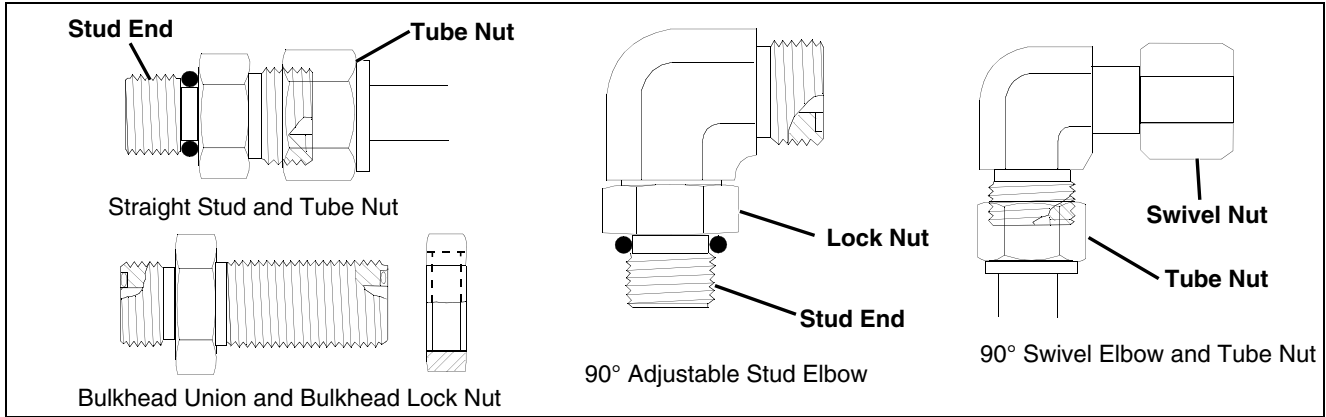

MIF

Nominal Tube OD/Hose ID				Face Seal Tube/Hose End				O-Ring Stud Ends			
Metric Tube OD	Inch Tube OD			Thread Size	Tube Nut/ Swivel Nut Torque		Bulkhead Lock Nut Torque		Thread Size	Straight Fitting or Lock Nut Torque	
	mm	Dash Size	in.		mm	in.	N•m	lb-ft		N•m	lb-ft
	-3	0.188	4.76						3/8-24	8	6
6	-4	0.250	6.35	9/16-18	16	12	12	9	7/16-20	12	9
8	-5	0.312	7.94						1/2-20	16	12
10	-6	0.375	9.52	11/16-16	24	18	24	18	9/16-18	24	18
12	-8	0.500	12.70	13/16-16	50	37	46	34	3/4-16	46	34
16	-10	0.625	15.88	1-14	69	51	62	46	7/8-14	62	46
	-12	0.750	19.05	1-3/16-12	102	75	102	75	1-1/16-12	102	75
22	-14	0.875	22.22	1-3/16-12	102	75	102	75	1-3/16-12	122	90
25	-16	1.000	25.40	1-7/16-12	142	105	142	105	1-5/16-12	142	105
32	-20	1.25	31.75	1-11/16-12	190	140	190	140	1-5/8-12	190	140
38	-24	1.50	38.10	2-12	217	160	217	160	1-7/8-12	217	160

NOTE: Torque tolerance is +15%, -20%.

SPECIFICATIONS AND INFORMATION GENERAL INFORMATION

Face Seal Fittings with Metric Stud Ends Torque

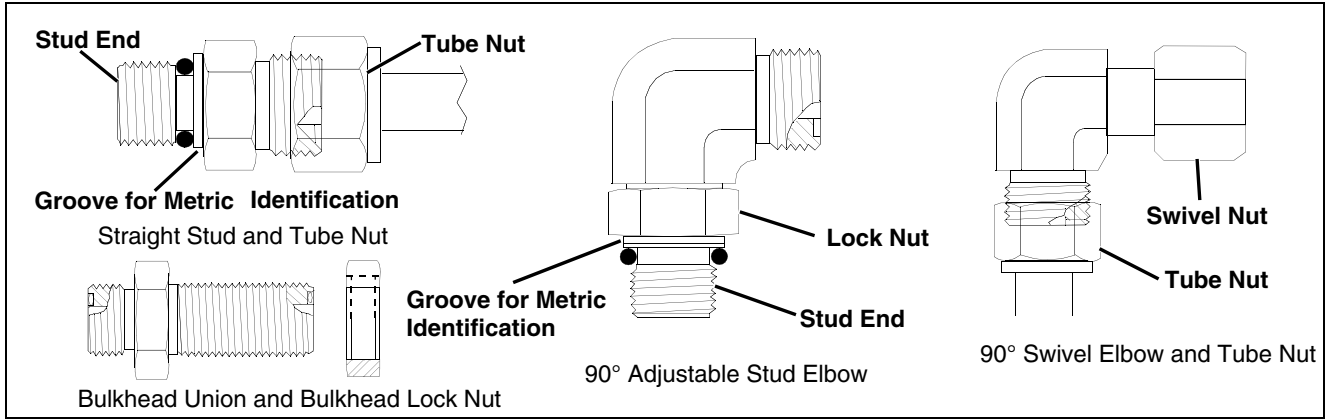

MIF

Nominal Tube OD/Hose ID				Face Seal Tube/Hose End						O-Ring Stud Ends, Straight Fitting or Lock Nut					
Metric Tube OD	Inch Tube OD			Thread Size	Hex Size	Tube Nut/ Swivel Nut Torque		Bulkhead Lock Nut Torque		Thread Size	Hex Size	Steel or Gray Iron Torque		Aluminum Torque	
	mm	Dash Size	in.			mm	in.	mm	N•m			lb-ft	N•m	lb-ft	mm
6	-4	0.250	6.35	9/16-18	17	16	12	12	9	M12X1.5	17	21	15.5	9	6.6
8	-5	0.312	7.94												
										M14X1.5	19	33	24	15	11
10	-6	0.375	9.52	11/16-16	22	24	18	24	18	M16X1.5	22	41	30	18	13
12	-8	0.500	12.70	13/16-16	24	50	37	46	34	M18X1.5	24	50	37	21	15
16	-10	0.625	15.88	1-14	30	69	51	62	46	M22X1.5	27	69	51	28	21
	-12	0.750	19.05	1-3/16-12	36	102	75	102	75	M27X2	32	102	75	46	34
22	-14	0.875	22.22	1-3/16-12	36	102	75	102	75	M30X2	36				
25	-16	1.000	25.40	1-7/16-12	41	142	105	142	105	M33X2	41	158	116	71	52
28										M38X2	46	176	130	79	58
32	-20	1.25	31.75	1-11/16-12	50	190	140	190	140	M42X2	50	190	140	85	63
38	-24	1.50	38.10	2-12	60	217	160	217	160	M48X2	55	217	160	98	72

NOTE: Torque tolerance is +15%, -20%.

SPECIFICATIONS AND INFORMATION GENERAL INFORMATION

O-Ring Face Seal Fittings

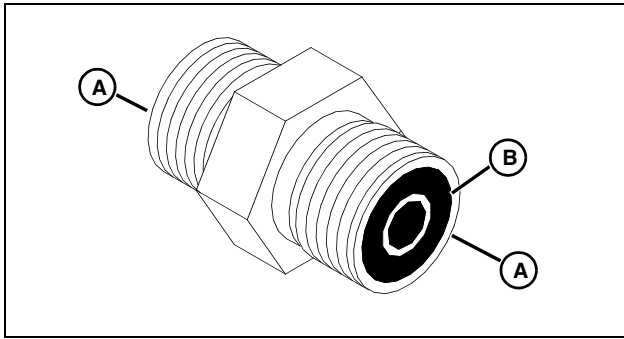

1. Inspect the fitting sealing surfaces (A). They must be free of dirt or defects.
2. Inspect the O-ring (B). It must be free of damage or defects.
3. Lubricate O-rings and install into groove using petroleum jelly to hold in place.
4. Push O-ring into the groove with plenty of petroleum jelly so O-ring is not displaced during assembly.
5. Index angle fittings and tighten by hand-pressing joint together to ensure O-ring remains in place.

IMPORTANT: Avoid damage! DO NOT allow hoses to twist when tightening fittings. Use two wrenches to tighten hose connections: one to hold the hose, and the other to tighten the swivel fitting.

6. Tighten fitting or nut to torque value shown on the chart per dash size stamped on the fitting.

O-Ring Boss Fittings

1. Inspect O-ring boss seat. It must be free of dirt and defects. If repeated leaks occur, inspect for defects with a magnifying glass. Some raised defects can be removed with a slip stone.

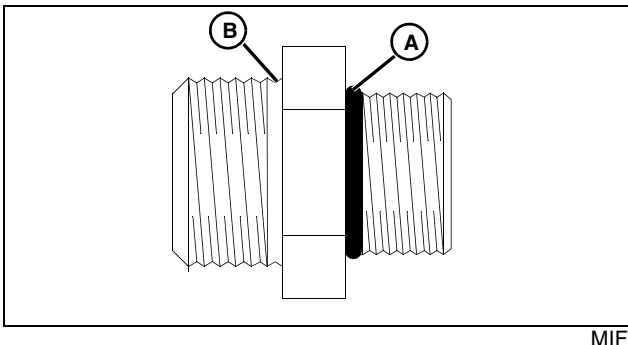

2. Put hydraulic oil or petroleum jelly on the O-ring (A). Place electrical tape over the threads to protect O-ring from nicks. Slide O-ring over the tape and into the groove (B) of fitting. Remove tape.

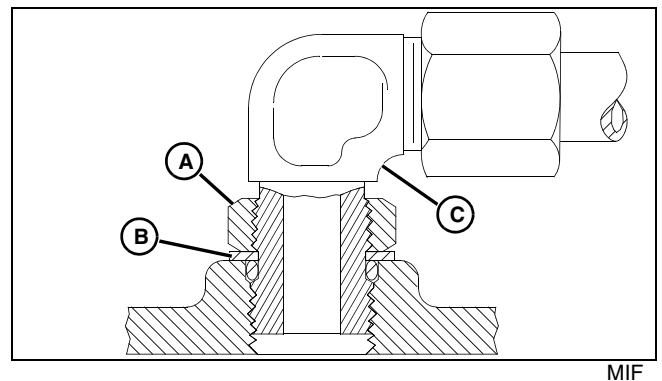

3. For angle fittings, loosen special nut (A) and push special washer (B) against threads so O-ring can be installed into the groove of fitting.
4. Turn fitting into the boss by hand until special washer or washer face (straight fitting) contacts boss face and O-ring is squeezed into its seat.
5. To position angle fittings (C), turn the fitting counter-clockwise a maximum of one turn.
6. Tighten straight fittings to torque value shown on chart. For angle fittings, tighten the special nut to value shown in the chart while holding body of fitting with a wrench.

Thread Size	Torque ¹		Number of Flats ²
	N·m	lb-ft	
3/8-24 UNF	8	6	2
7/16-20 UNF	12	9	2
1/2-20 UNF	16	12	2
9/16-18 UNF	24	18	2
3/4-16 UNF	46	34	2
7/8-14 UNF	62	46	1-1/2
1-1/16-12 UN	102	75	1
1-3/16-12 UN	122	90	1
1-5/16-12 UN	142	105	3/4
1-5/8-12 UN	190	140	3/4
1-7/8-12 UN	217	160	1/2

1. Torque tolerance is ± 10 percent.

2. To be used if a torque wrench cannot be used. After tightening fitting by hand, put a mark on nut or boss, then tighten special nut or straight fitting the number of flats shown.

SPECIFICATIONS AND INFORMATION GENERAL INFORMATION

Diesel Fuel - North America

In general, diesel fuels are blended to satisfy the low air temperature requirements of the geographical area in which they are sold.

In North America, diesel fuel is usually specified to **ASTM D975** and sold as either **Grade 1** for cold air temperatures or **Grade 2** for warm air temperatures.

If diesel fuels being supplied in your area DO NOT meet any of the above specifications, use diesel fuels with the following equivalent properties:

- Cetane Number 40 (Min)

A cetane number greater than 50 is preferred, especially for air temperatures below -20°C (-4°F) or elevations above 1500 m (5000 ft).

- Cold Filter Plugging Point (CFPP)

The temperature at which diesel fuel begins to cloud or jell. Use diesel fuels with a CFPP which is at least 5°C (9°F) below the expected low air temperature.

- Sulfur Content of 0.05% (Max)

Diesel fuels for highway use in the United States now require sulfur content to be less than 0.05%.

If diesel fuel being used has a sulfur content greater than 0.5%, reduce the service interval for engine oil and filter by 50%.



CAUTION: Avoid injury! California Proposition 65 Warning: Diesel engine exhaust and some of its elements from this product are known to the State of California to cause cancer, birth defects, or other reproductive harm.

Consult your local diesel fuel distributor for properties of the diesel fuel available in your area.

Diesel Fuel - Europe

In general, diesel fuels are blended to satisfy the low air temperature requirements of the geographical area in which they are sold.

In Europe, diesel fuel is usually specified to **EN590** and sold in 5 different classes or 6 different grades.

If diesel fuels being supplied in your area DO NOT meet any of the above specifications, use diesel fuels with the following equivalent properties:

- Cetane Number 40 (Min)

A cetane number greater than 50 is preferred, especially for air temperatures below -20°C (-4°F) or elevations above 1500 m (5000 ft).

- Cold Filter Plugging Point (CFPP)

The temperature at which diesel fuel begins to cloud or jell. Use diesel fuels with a CFPP which is at least 5°C (9°F) below the expected low air temperature.

- Sulfur Content of 0.05% (Max)

If diesel fuel being used has a sulfur content greater than 0.5%, reduce the service interval for engine oil and filter by 50%.

Consult your local diesel fuel distributor for properties of the diesel fuel available in your area.

Diesel Fuel Lubricity

Diesel fuel must have adequate lubricity to ensure proper operation and durability of fuel injection system components. Fuel lubricity should pass a minimum of 3300 gram load level as measured by the BOCLE scuffing test.

SPECIFICATIONS AND INFORMATION GENERAL INFORMATION

Diesel Fuel Storage

IMPORTANT: Avoid damage! DO NOT USE GALVANIZED CONTAINERS - diesel fuel stored in galvanized containers reacts with zinc coating in the container to form zinc flakes. If fuel contains water, a zinc gel will also form. The gel and flakes will quickly plug fuel filters and damage fuel injectors and fuel pumps.

It is recommended that diesel fuel be stored ONLY in a clean, approved POLYETHYLENE PLASTIC container WITHOUT any metal screen or filter. This will help prevent any accidental sparks from occurring. Store fuel in an area that is well ventilated to prevent possible igniting of fumes by an open flame or spark; this includes any appliance with a pilot light.

IMPORTANT: Avoid damage! Keep all dirt, scale, water, or other foreign material out of fuel.

Keep fuel in a safe, protected area and in a clean, properly marked ("DIESEL FUEL") container. DO NOT use deicers to attempt to remove water from fuel. DO NOT depend on fuel filters to remove water from fuel. It is recommended that a water separator be installed in the storage tank outlet. BE SURE to properly discard unstable or contaminated diesel fuel and/or their containers when necessary.

4-Cycle Diesel Engine Oil - North America

Use the appropriate oil viscosity based on the expected air temperature range during the period between recommended oil changes. Operating outside of these recommended oil air temperature ranges may cause premature engine failure.

The following John Deere oils are PREFERRED:

- **PLUS-50®-SAE 15W-40.**
- **TORQ-GARD SUPREME®-SAE 5W-30.**

The following John Deere oils are also recommended, based on their specified temperature range:

- **TURF-GARD®-SAE 10W-30.**
- **PLUS-4®-SAE 10W-30.**
- **TORQ-GARD SUPREME®-SAE 30.**

Other oils may be used if above John Deere oils are not available, provided they meet one of the following specifications:

- SAE 15W-40-API Service Classification CF-4 or higher.
- SAE 5W-30-API Service Classification CC or higher.
- SAE 10W-30-API Service Classification CF or higher.
- SAE 30-API Service Classification CF or higher.

IMPORTANT: Avoid damage! If diesel fuel with sulfur content greater than 0.5% is used, reduce the service interval for oil and filter by 50%.

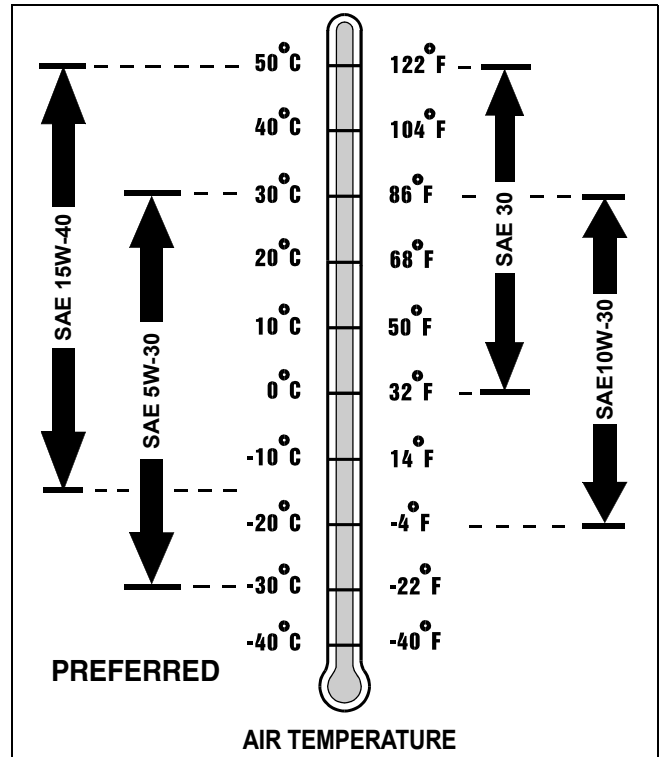

M58275

John Deere Dealers: You may want to cross-reference the following publications to recommend the proper oil for your customers:

- Module DX, ENOIL in JDS-G135.
- Section 530, Lubricants & Hydraulics, of the John Deere Merchandise Sales Guide.
- Lubrication Sales Manual PI7032.

SPECIFICATIONS AND INFORMATION GENERAL INFORMATION

4-Cycle Diesel Engine Oil - Europe

Use the appropriate oil viscosity based on the expected air temperature range during the period between recommended oil changes. Operating outside of these recommended oil air temperature ranges may cause premature engine failure.

The following John Deere oils are PREFERRED:

- TORQ-GARD SUPREME®-SAE 15W-40.
- UNI-GARD™-SAE 15W-40.
- TORQ-GARD SUPREME®-SAE 5W-30.
- UNI-GARD™-SAE 5W-30.

The following John Deere oils are also recommended, based on their specified temperature range:

- TORQ-GARD SUPREME®-SAE 10W-30.
- UNI-GARD™-SAE 10W-30.
- TORQ-GARD SUPREME®-SAE 30.
- UNI-GARD™-SAE 30.

Other oils may be used if above John Deere oils are not available, provided they meet the following specification:

- CCMC Specification D4 or Mercedes Benz MB228.1 or higher.

John Deere Dealers: You may want to cross-reference the following publications to recommend the proper oil for your customers:

- Module DX, ENOIL in JDS-G135.
- Section 530, Lubricants & Hydraulics, of the John Deere Merchandise Sales Guide.

IMPORTANT: Avoid damage! If diesel fuel with sulfur content greater the 0.5% is used, reduce the service interval for oil and filter by 50%.

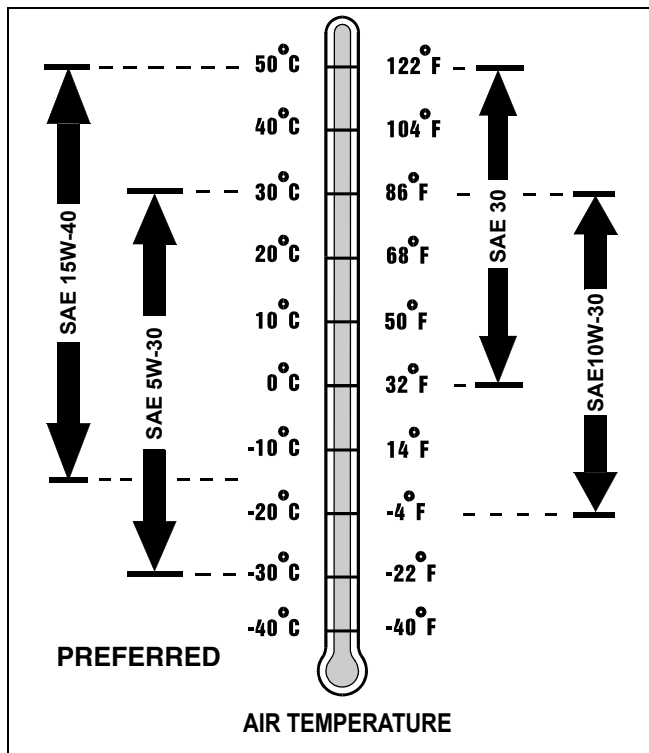

M58275

SPECIFICATIONS AND INFORMATION GENERAL INFORMATION

Break-In Diesel Engine Oil - North America

IMPORTANT: Avoid damage! ONLY use this specified break-in oil in rebuilt or remanufactured engines for the first 100 hours (Max) of operation. DO NOT use PLUS-50®, SAE 15W40 oil or oils meeting specifications API CG-4 or API CF-4; these oils will not allow rebuilt or remanufactured engines to break in properly.

The following John Deere oil is PREFERRED:

- **BREAK-IN ENGINE OIL.**

John Deere BREAK-IN ENGINE OIL is formulated with special additives for aluminum and cast iron type engines to allow the power cylinder components (pistons, rings, and liners as well) to “wear in” while protecting other engine components, valve train and gears, from abnormal wear. Engine rebuild instructions should be followed closely to determine if special requirements are necessary.

John Deere BREAK-IN ENGINE OIL is also recommended for non-John Deere engines, both aluminum and cast iron types.

If this preferred John Deere oil is not available, use a break-in engine oil meeting the following specification during the first 100 hours of operation:

- API Service Classification CE or higher.

IMPORTANT: Avoid damage! After the break-in period, use the John Deere oil that is recommended for this engine.

John Deere Dealers: You may want to cross-reference the following publications to recommend the proper oil for your customers:

- Module DX, ENOIL4 in JDS-G135.
- Section 530, Lubricants & Hydraulics, of the John Deere Merchandise Sales Guide.
- Lubrication Sales Manual PI7032.

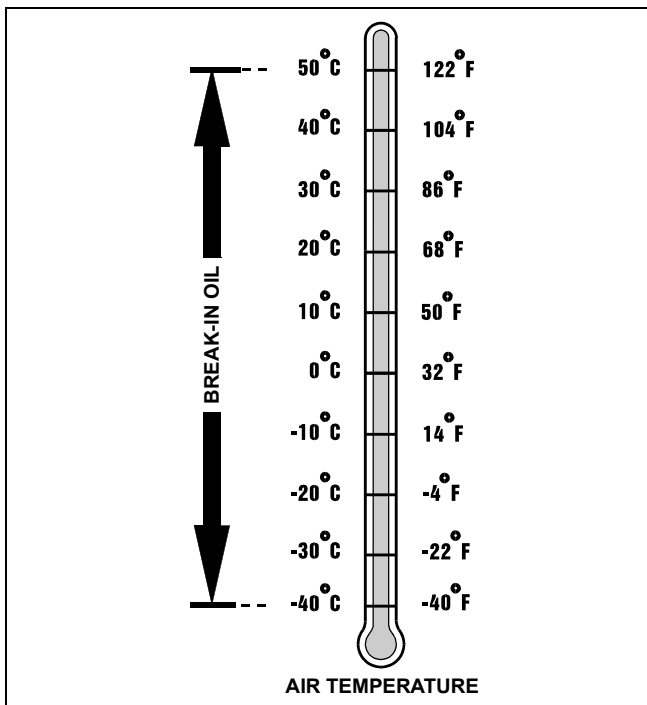

M58275

SPECIFICATIONS AND INFORMATION GENERAL INFORMATION

Break-In Diesel Engine Oil - Europe

IMPORTANT: Avoid damage! ONLY use this specified break-in oil in rebuilt or remanufactured engines for the first 100 hours (Max) of operation. DO NOT use SAE 14W40 oil or oils meeting CCMC Specification D5 - these oils will not allow rebuilt or remanufactured engines to break in properly.

The following John Deere oil is PREFERRED:

- **BREAK-IN ENGINE OIL.**

John Deere BREAK-IN ENGINE OIL is formulated with special additives for aluminum and cast iron type engines to allow the power cylinder components (pistons, rings, and liners as well) to “wear in” while protecting other engine components, valve train and gears, from abnormal wear. Engine rebuild instructions should be followed closely to determine if special requirements are necessary.

John Deere BREAK-IN ENGINE OIL is also recommended for non-John Deere engines, both aluminum and cast iron types.

If preferred John Deere oil is not available, use a break-in engine oil meeting the following specification during the first 100 hours of operation:

- CCMC Specification D4 or higher.

IMPORTANT: Avoid damage! After the break-in period, use the John Deere oil that is recommended for this engine.

John Deere Dealers: You may want to cross-reference the following publications to recommend the proper oil for your customers:

- Module DX, ENOIL4 in JDS-G135.
- Section 530, Lubricants & Hydraulics, of the John Deere Merchandise Sales Guide.

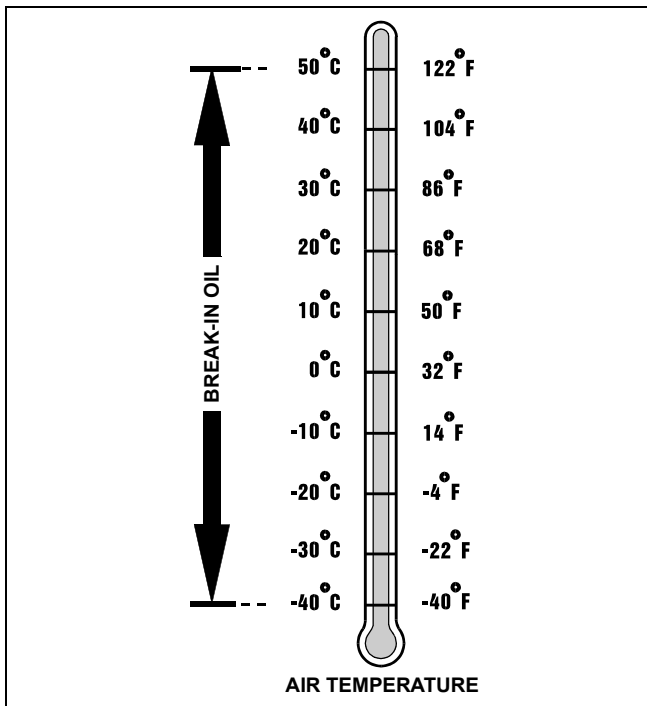

M58275

SPECIFICATIONS AND INFORMATION GENERAL INFORMATION

Hydrostatic Transmission and Hydraulic Oil

Use the following oil viscosity based on the air temperature range. Operating outside of the recommended oil air temperature range may cause premature hydrostatic transmission or hydraulic system failures.

IMPORTANT: Avoid damage! DO NOT use engine oil or "Type F" (Red) Automatic Transmission Fluid in this transmission. DO NOT mix any other oils in this transmission.

The following John Deere transmission and hydraulic oil is PREFERRED:

- **HY-GARD®-JDM J20C.**

Other oils may be used if above recommended John Deere oil is not available, provided they meet the following specification:

- John Deere Standard JDM J20C.

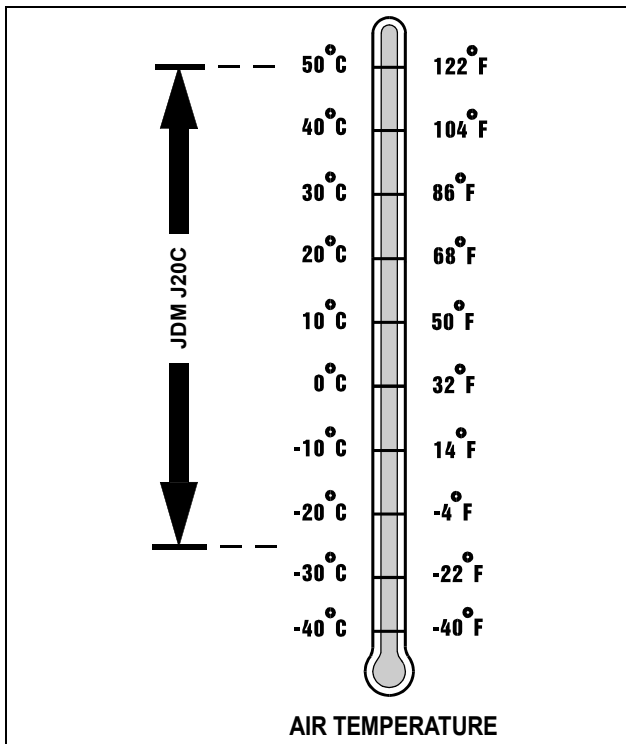

M58275

John Deere Dealers: You may want to cross-reference the following publications to recommend the proper oil for your customers:

- Module DX,ANTI in JDS-G135.
- Section 530, Lubricants & Hydraulics, of the John Deere Merchandise Sales Guide.
- Lubrication Sales Manual PI7032.

Biodegradable Oil

Application

IMPORTANT: Avoid damage! Biodegradable oils, other than BIO HY-GARD, are not recommended.

When use of a biodegradable lubricant is desired or required, BIO HY-GARD is recommended. BIO HY-GARD may be used under normal mowing conditions.

DO NOT USE biodegradable lubricants in machines for the following operations:

- Any machine used for scalping procedure.
- Any verticut operation in temperatures exceeding 32°C (90°F).

BIO HY-GARD should be used only in cases where the benefits of its use offset the extra initial cost, the increased oil change cost and the potential increasing maintenance costs for hydraulic systems with high temperatures and heavy loads.

- If the natural color of the fluid has become black, it is possible an overheating problem exists. The fluid should be changed.
- If the fluid becomes milky, water contamination may be a problem. Investigate the source of the contamination.
- Take fluid level reading when system is cold.
- Mixing of biodegradable oil and mineral oil will reduce the biodegradability of the lubricant in the machine. Mixing of HY-GARD and BIO HY-GARD will not result in performance deterioration.

Cold Weather Operation

Precautions should be taken if BIO HY-GARD containers or equipment are stored for long periods of time in extremely cold temperatures. Freezing should be expected if BIO HY-GARD is subjected to the following temperatures:

- Stored for six months at -20° to -23°C (-1° to -10°F)
- Stored for seven days at -23° to -26°C (-10° to -15°F)
- Stored for three days at -26° to -29°C (-15° to -20°F)
- Stored for two days at -29° to -35°C (-20° to -30°F)
- Stored for one day at -35°C (-30°F) and below.

IMPORTANT: Avoid damage! Equipment should not be started or any operation attempted until BIO HY-GARD has reached a safe operating viscosity.

If freezing of BIO HY-GARD is suspected, the container or equipment MUST be warmed to at least 0°C (32°F) and maintained for 24-48 hours to ensure the fluid has reached a safe operating viscosity.

SPECIFICATIONS AND INFORMATION GENERAL INFORMATION

Converting from HY-GARD to BIO HY-GARD

Systems being converted from HY-GARD to BIO HY-GARD should follow the procedure listed below to obtain maximum lubricant biodegradability.

1. Park machine on a level surface.
2. Lower cutting units, stop engine, set park brake and remove key from ignition.
3. Drain hydraulic reservoir.
4. Replace hydraulic filter.
5. Fill reservoir with BIO HY-GARD to appropriate level.
6. Start engine and bring to medium idle.
7. Turn steering wheel full stroke several times and cycle cutting units several times.
8. Stop engine and check hydraulic oil level. Add BIO HY-GARD to appropriate level.
9. Operate machine under normal operating conditions for a minimum of two hours.
10. Repeat steps 1-7.
11. Follow recommended maintenance schedules.

Anti-Corrosion Grease

This anti-corrosion grease is formulated to provide the best protection against absorbing moisture, which is one of the major causes of corrosion. This grease is also superior in its resistance to separation and migration.

The following anti-corrosion grease is PREFERRED:

- DuBois MPG-2® Multi-Purpose Polymer Grease-M79292.

Other greases may be used if they meet or exceed the following specifications:

- John Deere Standard JDM J13A2, NLGI Grade 1.

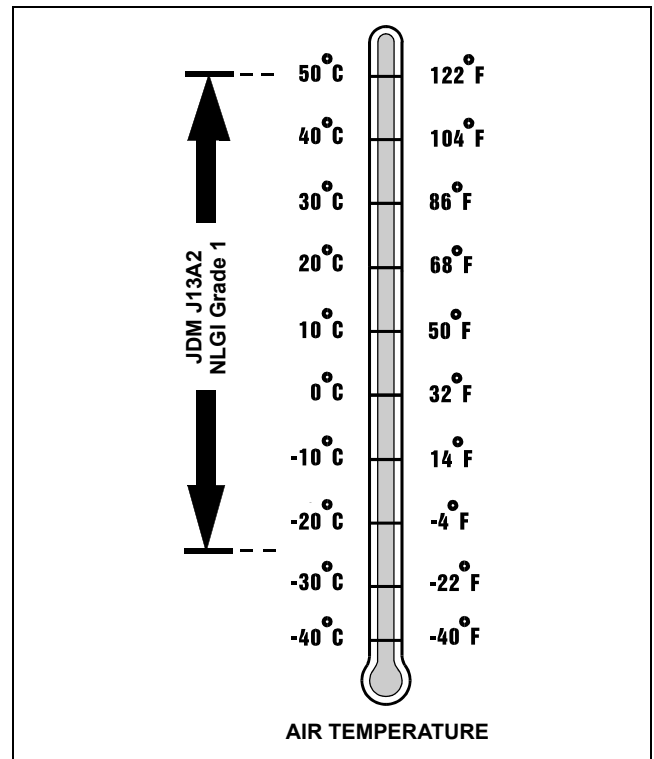

M58275

John Deere Dealers: You may want to cross-reference the following publications to recommend the proper grease for your customers:

- Module DX,GREA1 in JDS-G135.
- Section 530, Lubricants & Hydraulics, of the John Deere Merchandise Sales Guide.
- Lubrication Sales Manual PI7032.

SPECIFICATIONS AND INFORMATION GENERAL INFORMATION

Grease - North America

Use the following grease based on the air temperature range. Operating outside of the recommended grease air temperature range may cause premature failures.

IMPORTANT: Avoid damage! ONLY use a quality grease in this application. DO NOT mix any other greases in this application. DO NOT use any BIO-GREASE in this application.

The following John Deere greases are PREFERRED:

- Multi-Purpose SD Polyurea (TY6341).
- Special-Purpose HD Moly (TY6333).
- Reel Support Grease-Special Purpose Golf and Turf Cutting Unit Grease (TY25083).

Other greases may be used if above preferred John Deere greases are not available, provided they meet the following specifications:

Reel Support Grease Applications:

- Polyurea Grease-NLGI Grade 0.
- Calcium Complex Grease-NLGI Grade 0.
- Lithium Complex Grease-NLGI Grade 0.
- John Deere Standard JDM J13E4, NLGI Grade 2.

John Deere Dealers: You may want to cross-reference the following publications to recommend the proper grease for your customers:

- Module DX,GREA1 in JDS-G135.
- Section 530, Lubricants & Hydraulics, of the John Deere Merchandise Sales Guide.
- Lubrication Sales Manual PI7032.

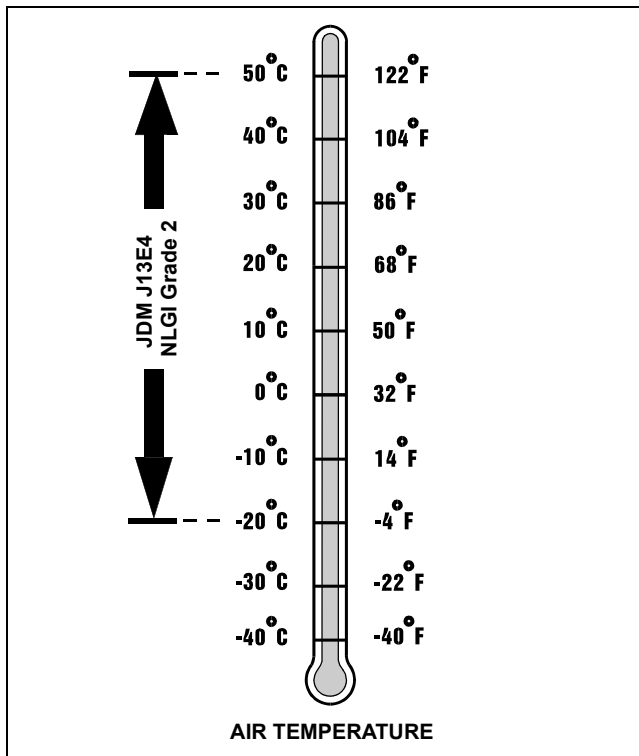

M58275

SPECIFICATIONS AND INFORMATION GENERAL INFORMATION

Grease - Europe

Use the following grease based on the air temperature range. Operating outside of the recommended grease air temperature range may cause premature failures.

IMPORTANT: Avoid damage! ONLY use a quality grease in this application. DO NOT mix any other greases in this application. DO NOT use any BIO-GREASE in this application.

The following John Deere greases are PREFERRED:

- **GREASE-GARD™-JDM J13E4, NLGI Grade 2.**
- **Reel Support Grease-JDM J13E6, NLGI Grade 0.**

Other greases may be used if above preferred John Deere greases are not available, provided they meet the following specifications:

Reel Support Grease Applications:

- Polyurea Grease-NLGI Grade 0.
- Calcium Complex Grease Grade 0.
- Lithium Complex Grease-NLGI Grade 0.
- John Deere Standard JDM J13E4, NLGI Grade 2.

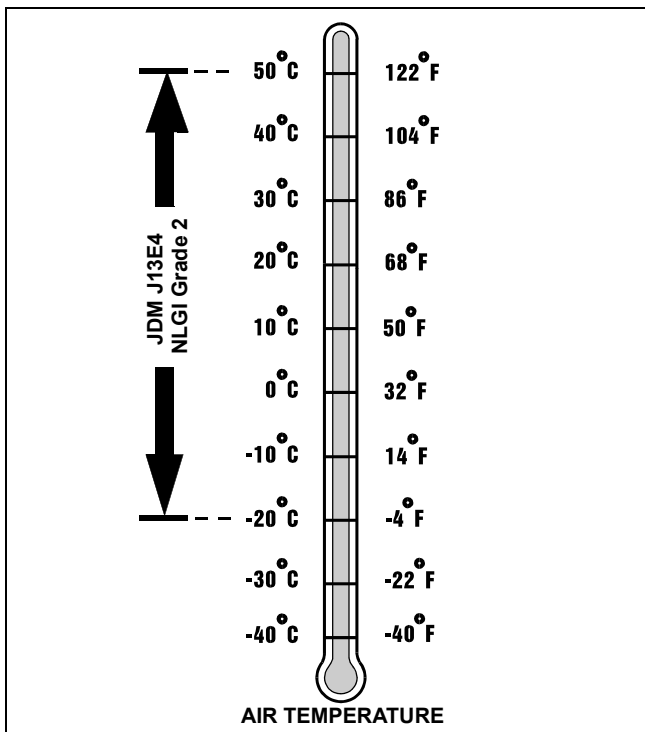

M58275

John Deere Dealers: You may want to cross-reference the following publications to recommend the proper grease for your customers:

- Module DX,GREA1 in JDS-G135.
- Section 530, Lubricants & Hydraulics, of the John Deere Merchandise Sales Guide.

Alternative Lubricants

Conditions in certain geographical areas outside the United States and Canada may require different lubricant recommendations than the ones printed in this technical manual or the operator's manual. Consult with your John Deere Dealer, or Sales Branch, to obtain the alternative lubricant recommendations.

IMPORTANT: Avoid damage! Use of alternative lubricants could cause reduced life of the component.

If alternative lubricants are to be used, it is recommended that the factory fill be thoroughly removed before switching to any alternative lubricant.

Synthetic Lubricants

Synthetic lubricants may be used in John Deere equipment if they meet the applicable performance requirements (industry classification and/or military specification) as shown in this manual.

The recommended air temperature limits and service or lubricant change intervals should be maintained as shown in the operator's manual.

Avoid mixing different brands, grades, or types of oil. Oil manufacturers blend additives in their oils to meet certain specifications and performance requirements. Mixing different oils can interfere with the proper functioning of these additives and degrade lubricant performance.

Lubricant Storage

All machines operate at top efficiency only when clean lubricants are used. Use clean storage containers to handle all lubricants. Store them in an area protected from dust, moisture, and other contamination. Store drums on their sides. Make sure all containers are properly marked as to their contents. Dispose of all old, used containers and their contents properly.

Mixing of Lubricants

In general, avoid mixing different brands or types of lubricants. Manufacturers blend additives in their lubricants to meet certain specifications and performance requirements. Mixing different lubricants can interfere with the proper functioning of these additives and lubricant properties which will downgrade their intended specified performance.

SPECIFICATIONS AND INFORMATION GENERAL INFORMATION

Oil Filters

IMPORTANT: Avoid damage! Filtration of oils is critical to proper lubrication performance. Always change filters regularly.

The following John Deere oil filters are **PREFERRED**:

- **Automotive and light truck engine oil filters.**

Most John Deere filters contain pressure relief and anti-drainback valves for better engine protection.

Other oil filters may be used if above recommended John Deere oil filters are not available, provided they meet the following specification:

- ASTB Tested in Accordance with SAE J806.

John Deere Dealers: You may want to cross-reference the following publications to recommend the proper oil filter for your customers:

- Module DX,FILT in JDS-G135.
- Section 540, Lubricants & Hydraulics, of the John Deere Merchandise Sales Guide.
- Lawn & Grounds Care Tune-Up Guide PI672.

Diesel Engine Coolant - North America

The engine cooling system when filled with a proper dilution mixture of anti-freeze and deionized or distilled water provides year-round protection against corrosion, cylinder or liner pitting, and winter freeze protection down to -37°C (-34°F).

The following John Deere coolant is **PREFERRED**:

- **PRE-DILUTED DIESEL ENGINE ANTI-FREEZE/SUMMER COOLANT™ (TY16036).**

This coolant satisfies specifications for “Automobile and Light Duty Engine Service” and is safe for use in John Deere Lawn and Grounds Care/Golf and Turf Division equipment, including aluminum block gasoline engines and cooling systems.

The above preferred pre-diluted anti-freeze provides:

- adequate heat transfer
- corrosion-resistant chemicals for the cooling system
- compatibility with cooling system hose and seal material
- protection during extreme cold and extreme hot weather operations
- chemically pure water for better service life
- compliance with ASTM D4656 (JDM H24C2) specifications

If above preferred pre-diluted coolant is not available, the following John Deere concentrate is recommended:

- **DIESEL ENGINE ANTI-FREEZE/SUMMER COOLANT CONCENTRATE™ (TY16034).**

If either of above recommended engine coolants are not available use any Automobile and Light Duty Engine Service ethylene glycol base coolant, meeting the following specification:

- ASTM D3306 (JDM H24C1).

Read container label completely before using and follow instructions as stated.

IMPORTANT: Avoid damage! To prevent engine damage, DO NOT use pure anti-freeze or less than a 50% anti-freeze mixture in the cooling system. DO NOT mix or add any additives/conditioners to the cooling system in Lawn and Grounds Care/Golf and Turf Division equipment. Water used to dilute engine coolant concentrate must be of high quality - clean, clear, potable water (low in chloride and hardness-Table 1) is generally acceptable. DO NOT use salt water. Deionized or distilled water is ideal to use. Coolant that is not mixed to these specified levels and water purity can cause excessive scale, sludge deposits, and increased corrosion potential.

Water Quality

Property	Requirements
Total Solids (Max)	340 ppm (20 grns/gal)
Total Hardness (Max)	170 ppm (10 grns/gal)
Chloride (as Cl) (Max)	40 ppm (2.5 grns/gal)
Sulfate (as SO ₄) (Max)	100 ppm (5.8 grns/gal)

Mix 50 percent anti-freeze concentrate with 50 percent distilled or deionized water. This mixture and the pre-diluted mixture (TY16036) will protect the cooling system down to a temperature of -37°C (-34°F) and up to 108°C (226°F).

Certain geographical areas may require lower air temperature protection. See the label on your anti-freeze container or consult your John Deere dealer to obtain the latest information and recommendations.

SPECIFICATIONS AND INFORMATION GENERAL INFORMATION

Diesel Engine Coolant Drain Interval - North America

When using John Deere Pre-Diluted (TY16036) Automobile and Light Duty Engine Service coolants, drain and flush the cooling system and refill with fresh coolant mixture every 36 months or 3,000 hours of operation, whichever comes first.

When using John Deere Concentrate (TY16034) Automobile and Light Duty Engine Service coolants, drain and flush the cooling system and refill with fresh coolant mixture every 24 months or 2,000 hours of operation, whichever comes first.

If above John Deere Automobile and Light Duty Engine Service coolants are not being used, drain, flush, and refill the cooling system according to instructions found on product container or in equipment operator's manual or technical manual.

Diesel Engine Coolant - Europe

The engine cooling system when filled with a proper dilution mixture of anti-freeze and deionized or distilled water provides year-round protection against corrosion, cylinder liner pitting, and winter freeze protection down to -37°C (-34°F).

The following John Deere coolant is **PREFERRED**:

- **COOL-GARD COOLANT CONCENTRATE™.**

If above preferred coolant is not available, use any Automobile and Light Duty Engine Service ethylene glycol base coolant, meeting the following specification:

- ASTM D3306 (JDM H24C1).

Read container label completely before using and follow instructions as stated.

IMPORTANT: Avoid damage! To prevent engine damage, DO NOT use pure anti-freeze or less than a 50% anti-freeze mixture in the cooling system. DO NOT mix or add any additives/conditioners to the cooling system in Lawn and Grounds Care/Golf and Turf Division equipment. Water used to dilute engine coolant concentrate must be of high quality - clean, clear, potable water (low in chloride and hardness-Table 1) is generally acceptable. DO NOT use salt water. Deionized or distilled water is best to use. Coolant that is not mixed to these specified levels and water purity can cause excessive scale, sludge deposits, and increased corrosion potential.

Water Quality	
Property	Requirements
Total Solids (Max)	340 ppm (20 grns/gal)
Total Hardness (Max)	170 ppm (10 grns/gal)
Chloride (as Cl) (Max)	40 ppm (2.5 grns/gal)
Sulfate (as SO ₄) (Max)	100 ppm (5.8 grns/gal)

Mix 50 percent anti-freeze concentrate with 50 percent distilled or deionized water. This mixture will protect the cooling system down to -37°C (-34°F) and up to 108°C (226°F).

Certain geographical areas may require lower air temperature protection. See the label on your anti-freeze container or consult your John Deere dealer to obtain the latest information and recommendations.

Diesel Engine Coolant Drain Interval - Europe

When using John Deere Cool-Gard Coolant Concentrate for Automobile and Light Duty Engine Service, drain and flush the cooling system and refill with fresh coolant mixture every 24 months or 2,000 hours of operation, whichever comes first.

If above John Deere Automobile and Light Duty Engine Service coolant is not being used, drain, flush, and refill the cooling system according to instructions found on product container or in equipment operator's manual or technical manual.

SPECIFICATIONS AND INFORMATION IDENTIFICATION NUMBERS

Product: John Deere 3215 3215A 3215B 3225B 3235 3235A 3235B Lightweight Fairway Mower Service Repair Technical Manual

Full Download: <https://www.bobmanualstore.com/downloads/john-deere-3215-3215a-3215b-3225b-3235-3235a-3235b-lightweight-fairway-mower-service-repair-technical-manual/>

Identification Numbers

Cutting Unit Serial Numbers

Serial Number Location

When ordering parts or submitting a warranty claim, it is **IMPORTANT** that you include the mower product identification number and the component serial numbers.

The locations of mower identification number and component serial numbers are shown.

Mower Identification Number

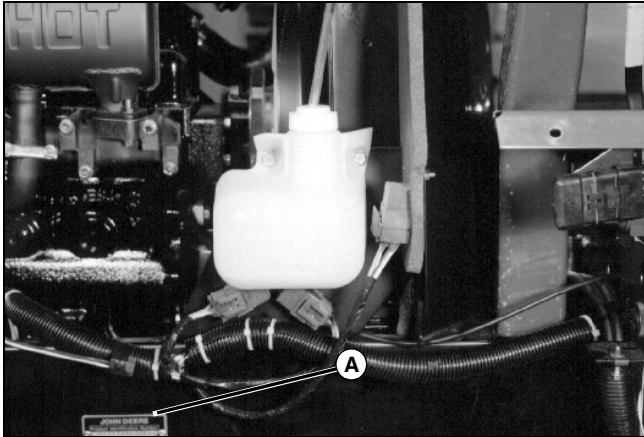

M76476

The mower identification number plate is (A) located on the right-hand frame under the engine compartment.

Engine Serial Number

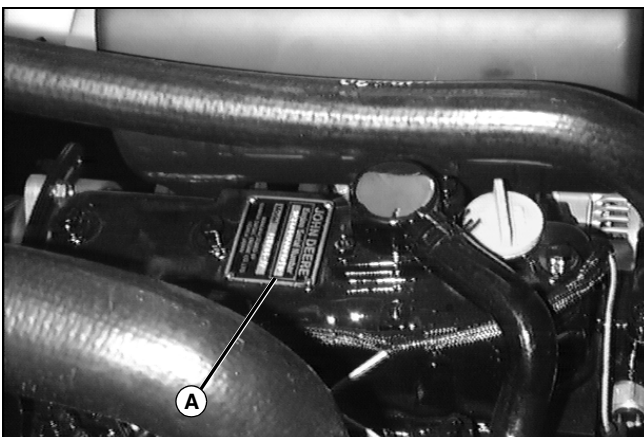

M58797

The engine serial number plate (A) is located on the top of the valve cover.

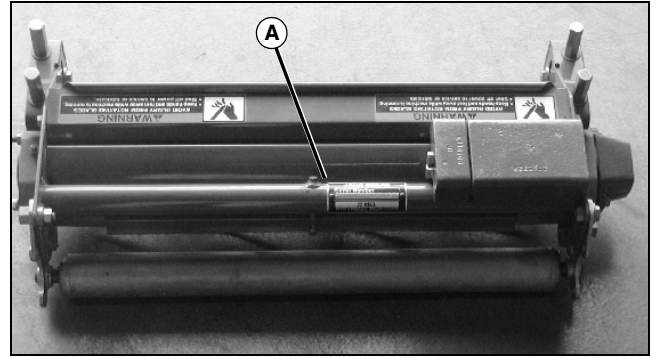

M84563

Picture Note: 22 In. Standard Cutting Unit

The cutting unit serial number plate (A) is located on top of the cutting unit.

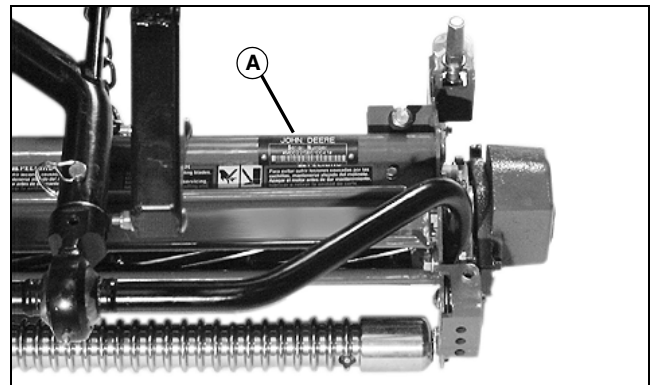

M84563

Picture Note: 2500M Cutting Unit

The cutting unit serial number plate (A) is located on top of the cutting unit.

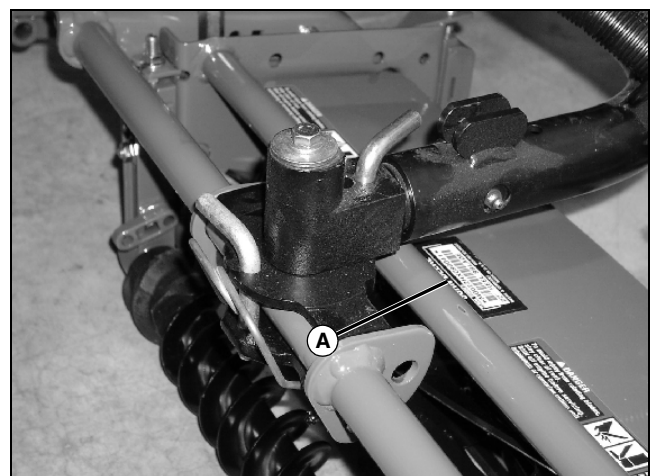

MX18036

Picture Note: 22" In. Heavy Duty

The cutting unit serial number plate (A) is located on top of the cutting unit.

Sample manual. Download All 492 pages at:

<https://www.bobmanualstore.com/downloads/john-deere-3215-3215a-3215b-3225b-3235-3235a-3235b-lightweight-fairway-mower-service-repair-technical-manual/>