

Product: John Deere 110 Loader Backhoe Tractor Service Repair Technical Manual

Full Download: <https://www.bobmanualstore.com/downloads/john-deere-110-loader-backhoe-tractor-service-repair-technical-manual/>

**JOHN DEERE**  
**WORLDWIDE COMMERCIAL & CONSUMER**  
**EQUIPMENT DIVISION**

---

**Tractor Loader Backhoe**  
**110**

TM1987 JUN02

**TECHNICAL MANUAL**

**JOHN DEERE**

North American Version  
Litho in U.S.A.

Sample manual. Download All 540 pages at:

<https://www.bobmanualstore.com/downloads/john-deere-110-loader-backhoe-tractor-service-repair-technical-manual/>

Product: John Deere 110 Loader Backhoe Tractor Service Repair Technical Manual

Full Download: <https://www.bobmanualstore.com/downloads/john-deere-110-loader-backhoe-tractor-service-repair-technical-manual/>

---

Sample manual. Download All 540 pages at:

<https://www.bobmanualstore.com/downloads/john-deere-110-loader-backhoe-tractor-service-repair-technical-manual/>

# INTRODUCTION

---

---

## Manual Description

This technical manual is written for an experienced technician and contains sections that are specifically for this product. It is a part of a total product support program.

The manual is organized so that all the information on a particular system is kept together. The order of grouping is as follows:

- Table of Contents
- Specifications and Information
- Identification Numbers
- Tools and Materials
- Component Location
- Schematics and Harnesses
- Theory of Operation
- Operation and Diagnostics
- Diagnostics
- Tests and Adjustments
- Repair
- Other

**NOTE: Depending on the particular section or system being covered, not all of the above groups may be used.**

The bleed tabs for the pages of each section will align with the sections listed on this page. Page numbering is consecutive from the beginning of the Safety section through the last section.

We appreciate your input on this manual. If you find any errors or want to comment on the layout of the manual please contact us.

Safety

Specifications and Information

Engine

Electrical

Power Train

Hydraulics

Steering

Brakes

Loader

Backhoe

Miscellaneous

All information, illustrations and specifications in this manual are based on the latest information at the time of publication. The right is reserved to make changes at any time without notice.

COPYRIGHT© 2002  
Deere & Co.  
John Deere Worldwide Commercial and  
Consumer Equipment Division  
All rights reserved  
Previous Editions  
COPYRIGHT©

# INTRODUCTION

---

---

# SAFETY

## Recognize Safety Information

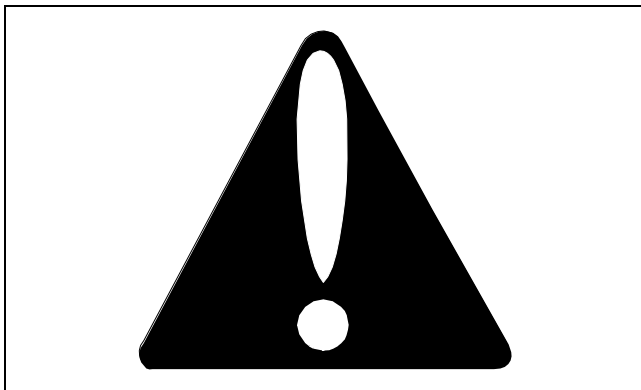

MIF

This is the safety-alert symbol. When you see this symbol on your machine or in this manual, be alert to the potential for personal injury.

Follow recommended precautions and safe servicing practices.

## Understand Signal Words

A signal word - DANGER, WARNING, or CAUTION - is used with the safety-alert symbol. DANGER identifies the most serious hazards.

DANGER or WARNING safety signs are located near specific hazards. General precautions are listed on CAUTION safety signs. CAUTION also calls attention to safety messages in this manual.

## Replace Safety Signs

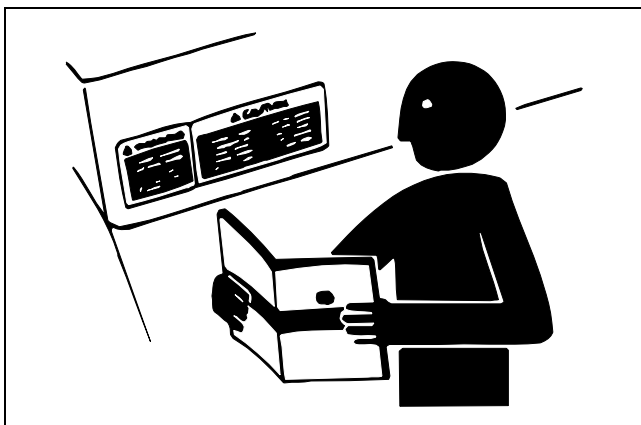

MIF

Replace missing or damaged safety signs. See the machine operator's manual for correct safety sign placement.

## Be Prepared for Emergencies

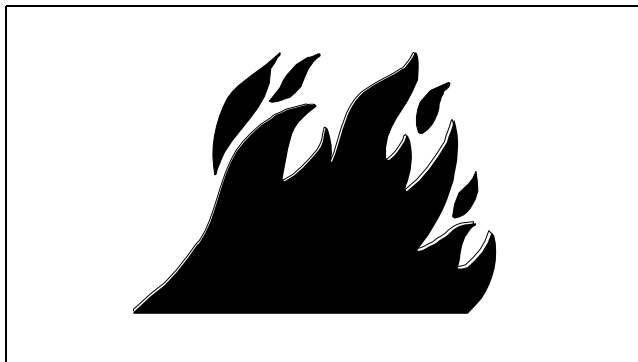

MIF

When you work around fuel, do not smoke or work near heaters or other fire hazards.

Store flammable fluids away from fire hazards. Do not incinerate or puncture pressurized containers.

Make sure machine is clean of trash, grease, and debris.

Do not store oily rags; they can ignite and burn spontaneously.

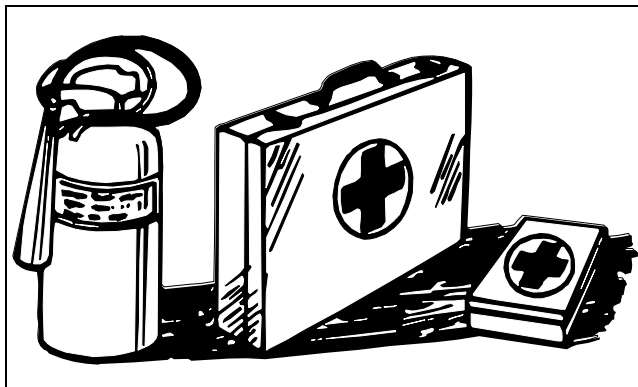

MIF

Be prepared if a fire starts.

Keep a first aid kit and fire extinguisher handy.

Keep emergency numbers for doctors, ambulance service, hospital, and fire department near your telephone.

# SAFETY

## Use Care in Handling and Servicing Batteries

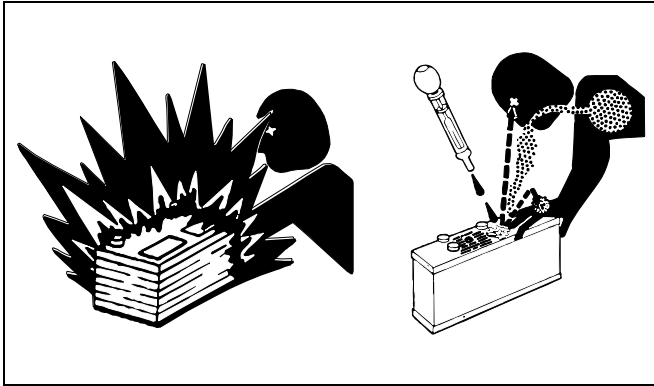

MIF

### Prevent Battery Explosions

- Keep sparks, lighted matches, and open flame away from the top of battery. Battery gas can explode.
- Never check battery charge by placing a metal object across the posts. Use a volt-meter or hydrometer.
- Do not charge a frozen battery; it may explode. Warm battery to 16°C (60°F).

### Prevent Acid Burns

Sulfuric acid in battery electrolyte is poisonous. It is strong enough to burn skin, eat holes in clothing, and cause blindness if splashed into eyes.

#### Avoid acid burns by:

1. Filling batteries in a well-ventilated area.
2. Wearing eye protection and rubber gloves.
3. Avoiding breathing fumes when electrolyte is added.
4. Avoiding spilling or dripping electrolyte.
5. Use proper jump start procedure.

#### If you spill acid on yourself:

1. Flush your skin with water.
2. Apply baking soda or lime to help neutralize the acid.
3. Flush your eyes with water for 10-15 minutes.
4. Get medical attention immediately.

#### If acid is swallowed:

1. Drink large amounts of water or milk.
2. Then drink milk of magnesia, beaten eggs, or vegetable oil.
3. Get medical attention immediately.

## Use Care Around High-Pressure Fluid Lines

### Avoid High-Pressure Fluids

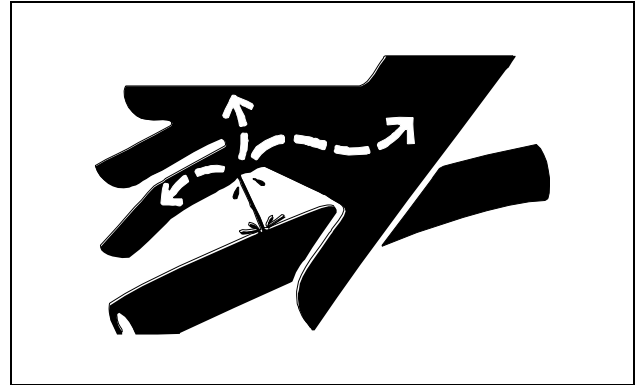

MIF

Escaping fluid under pressure can penetrate the skin causing serious injury.

Avoid injury from escaping fluid under pressure by stopping the engine and relieving pressure in the system before disconnecting or connecting hydraulic or other lines. Tighten all connections before applying pressure.

Search for leaks with a piece of cardboard. Protect hands and body from high pressure fluids.

If an accident occurs, see a doctor immediately. Any fluid injected into the skin must be surgically removed within a few hours or gangrene may result. Doctors unfamiliar with this type of injury should reference a knowledgeable medical source. Such information is available from Deere & Company Medical Department in Moline, Illinois, U.S.A.

### Avoid Heating Near Pressurized Fluid Lines



MIF

Flammable spray can be generated by heating near pressurized fluid lines, resulting in severe burns to yourself and bystanders. Do not heat by welding, soldering, or using a torch near pressurized fluid lines or other flammable materials. Pressurized lines can be accidentally cut when heat goes beyond the immediate flame area.

# SAFETY

## Use Safe Service Procedures

### Wear Protective Clothing

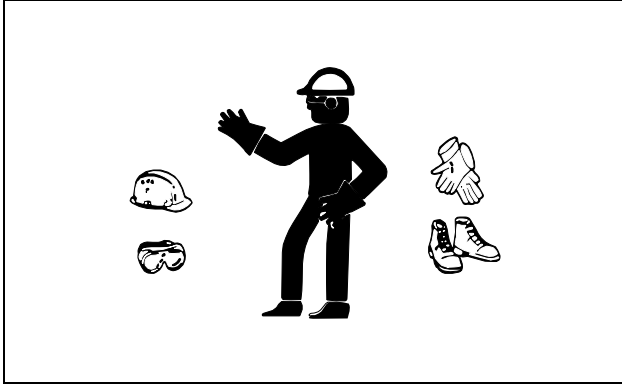

MIF

Wear close fitting clothing and safety equipment appropriate to the job.

Prolonged exposure to loud noise can cause impairment or loss of hearing. Wear a suitable hearing protective device such as earmuffs or earplugs to protect against objectionable or uncomfortable loud noises.

Operating equipment safely requires the full attention of the operator. Do not wear radio or music headphones while operating machine.

### Service Machines Safely

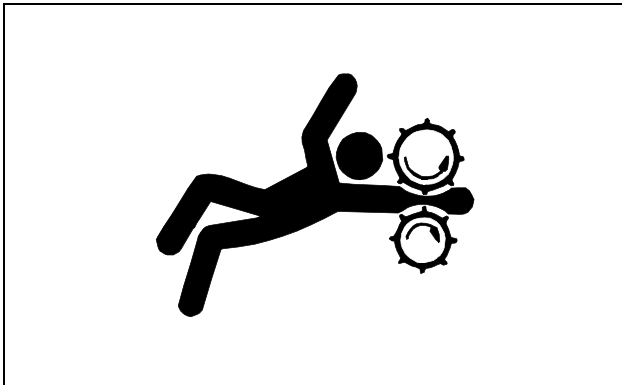

MIF

Tie long hair behind your head. Do not wear a necktie, scarf, loose clothing, or necklace when you work near machine tools or moving parts. If these items were to get caught, severe injury could result.

Remove rings and other jewelry to prevent electrical shorts and entanglement in moving parts.

### Use Proper Tools

Use tools appropriate to the work. Makeshift tools and procedures can create safety hazards. Use power tools only to loosen threaded parts and fasteners. For loosening and tightening hardware, use the correct size tools. **DO NOT** use U.S. measurement tools on metric fasteners.

Avoid bodily injury caused by slipping wrenches. Use only service parts meeting John Deere specifications.

### Park Machine Safely

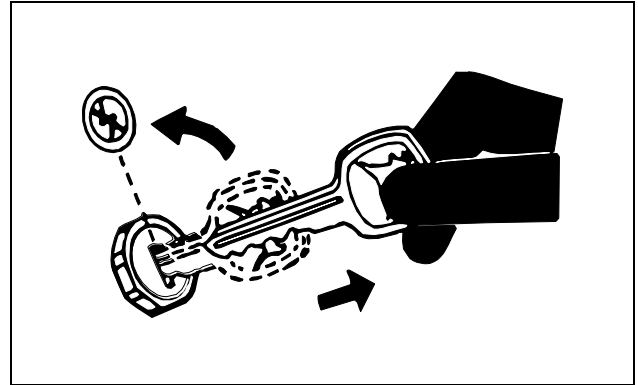

MIF

### Before working on the machine:

1. Lower all equipment to the ground.
2. Stop the engine and remove the key.
3. Disconnect the battery ground strap.
4. Hang a "DO NOT OPERATE" tag in operator station.

### Support Machine Properly and Use Proper Lifting Equipment

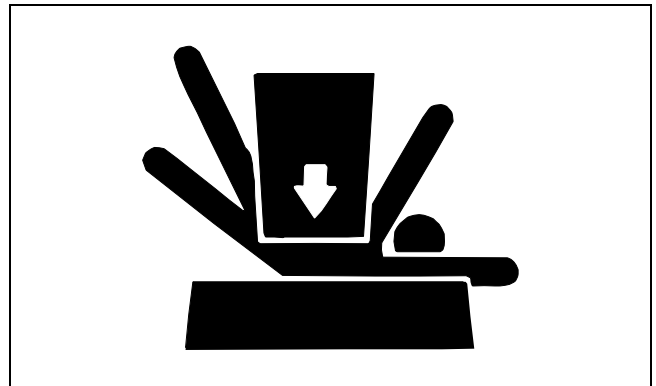

MIF

If you must work on a lifted machine or attachment, securely support the machine or attachment.

Do not support the machine on cinder blocks, hollow tiles, or props that may crumble under continuous load. Do not work under a machine that is supported solely by a jack. Follow recommended procedures in this manual.

Lifting heavy components incorrectly can cause severe injury or machine damage. Follow recommended procedure for removal and installation of components in the manual.

# SAFETY

## Work in Clean Area

### Before starting a job:

1. Clean work area and machine.
2. Make sure you have all necessary tools to do your job.
3. Have the right parts on hand.
4. Read all instructions thoroughly; do not attempt shortcuts.

## Using High Pressure Washers

Directing pressurized water at electronic/electrical components or connectors, bearings, hydraulic seals, fuel injection pumps or other sensitive parts and components may cause product malfunctions. Reduce pressure and spray at a 45 to 90 degree angle.

## Illuminate Work Area Safely

Illuminate your work area adequately but safely. Use a portable safety light for working inside or under the machine. Make sure the bulb is enclosed by a wire cage. The hot filament of an accidentally broken bulb can ignite spilled fuel or oil.

## Work in Ventilated Area

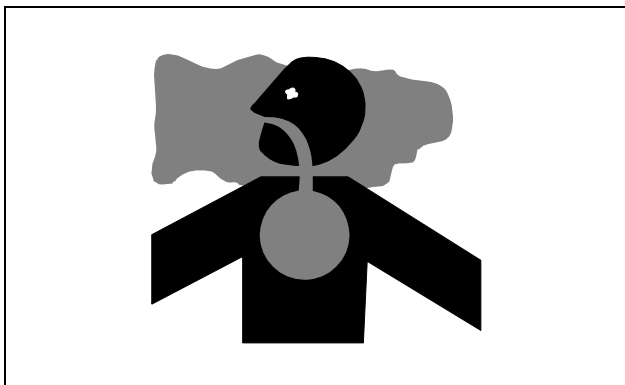

MIF

Engine exhaust fumes can cause sickness or death. If it is necessary to run an engine in an enclosed area, remove the exhaust fumes from the area with an exhaust pipe extension.

If you do not have an exhaust pipe extension, open the doors and get outside air into the area.

### **WARNING: California Proposition 65 Warning**

Diesel engine exhaust and some of its constituents are known to the State of California to cause cancer, birth defects, and other reproductive harm.

Gasoline engine exhaust from this product contains chemicals known to the State of California to cause cancer, birth defects, or other reproductive harm.

## Remove Paint before Welding or Heating

Avoid potentially toxic fumes and dust. Hazardous fumes can be generated when paint is heated by welding, soldering, or using a torch. Do all work outside or in a well-ventilated area. Dispose of paint and solvent properly. Remove paint before welding or heating. If you sand or grind paint, avoid breathing the dust. Wear an approved respirator. If you use solvent or paint stripper, remove stripper with soap and water before welding. Remove solvent or paint stripper containers and other flammable material from area. Allow fumes to disperse at least 15 minutes before welding or heating.

## Avoid Harmful Asbestos Dust

Avoid breathing dust that may be generated when handling components containing asbestos fibers. Inhaled asbestos fibers may cause lung cancer.

Components in products that may contain asbestos fibers are brake pads, brake band and lining assemblies, clutch plates, and some gaskets. The asbestos used in these components is usually found in a resin or sealed in some way. Normal handling is not hazardous as long as airborne dust containing asbestos is not generated.

Avoid creating dust. Never use compressed air for cleaning. Avoid brushing or grinding material containing asbestos. When servicing, wear an approved respirator. A special vacuum cleaner is recommended to clean asbestos. If not available, apply a mist of oil or water on the material containing asbestos. Keep bystanders away from the area.

## Service Tires Safely



MIF

Explosive separation of a tire and rim parts can cause serious injury or death.

Do not attempt to mount a tire unless you have the proper equipment and experience to perform the job. Always maintain the correct tire pressure. Do not inflate the tires above the recommended pressure. Never weld or heat a wheel and tire assembly. The heat can cause an increase in air pressure resulting in a tire explosion. Welding can

# SAFETY

structurally weaken or deform the wheel.

When inflating tires, use a clip-on chuck and extension hose long enough to allow you to stand to one side and NOT in front of or over the tire assembly. Use a safety cage if available.

Check wheels for low pressure, cuts, bubbles, damaged rims or missing lug bolts and nuts.

## Service Cooling System Safely

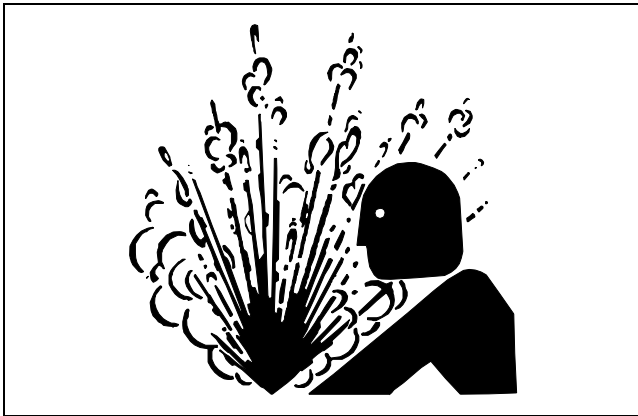

MIF

Explosive release of fluids from pressurized cooling system can cause serious burns.

Shut off machine. Only remove filler cap when cool enough to touch with bare hands. Slowly loosen cap to first stop to relieve pressure before removing completely.

## Handle Chemical Products Safely

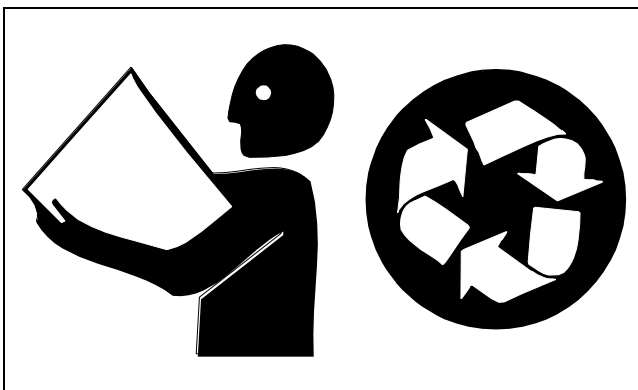

MIF

Direct exposure to hazardous chemicals can cause serious injury. Potentially hazardous chemicals used with John Deere equipment include such items as lubricants, coolants, paints, and adhesives.

A Material Safety Data Sheet (MSDS) provides specific details on chemical products: physical and health hazards, safety procedures, and emergency response techniques. Check the MSDS before you start any job using a

hazardous chemical. That way you will know exactly what the risks are and how to do the job safely. Then follow procedures and recommended equipment.

## Dispose of Waste Properly

Improperly disposing of waste can threaten the environment and ecology. Potentially harmful waste used with John Deere equipment include such items as oil, fuel, coolant, brake fluid, filters, and batteries. Use leakproof containers when draining fluids. Do not use food or beverage containers that may mislead someone into drinking from them. Do not pour waste onto the ground, down a drain, or into any water source. Inquire on the proper way to recycle or dispose of waste from your local environmental or recycling center, or from your John Deere dealer.

## Live with Safety



MIF

Before returning machine to customer, make sure machine is functioning properly, especially the safety systems. Install all guards and shields.

# SAFETY

---

---



# SPECIFICATIONS & INFORMATION TABLE OF CONTENTS

---

## Table of Contents

<b>Specifications</b> .....	<b>9</b>
Metric Fastener Torque Values .....	9
Metric Fastener Torque Values - Grade 7 .....	10
Inch Fastener Torque Values .....	11
Face Seal Fittings with Inch Stud Ends Torque .....	12
Face Seal Fittings with Metric Stud Ends Torque .....	13
O-Ring Face Seal Fittings .....	14
O-Ring Boss Fittings .....	14
Diesel Fuel .....	15
Diesel Fuel Lubricity .....	15
Diesel Fuel Storage.....	15
DIESELSCAN™ Fuel Analysis.....	15
Engine Oil.....	15
Engine Break-in Oil .....	16
OILSCAN®, OILSCAN Plus®, COOLSCAN™, and COOLSCAN PLUS™ .....	17
Alternative Lubricants.....	17
Synthetic Lubricants.....	17
Lubricant Storage .....	17
Mixing of Lubricants .....	17
Chassis Grease.....	18
Transaxle Oil .....	18
Engine Coolant.....	19
Testing Diesel Engine Coolant.....	20
Operating in Warm Temperature Climates.....	20
Flush and Service Cooling System .....	21
Disposing of Coolant .....	21
Engine Coolant Drain Interval .....	22
Machine Product Identification Number ...	22
Engine Serial Number Location.....	22
<b>General Information</b> .....	<b>23</b>
Interlock System.....	23

# SPECIFICATIONS & INFORMATION TABLE OF CONTENTS

---

---

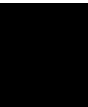

# SPECIFICATIONS & INFORMATION SPECIFICATIONS

## Specifications

## Metric Fastener Torque Values

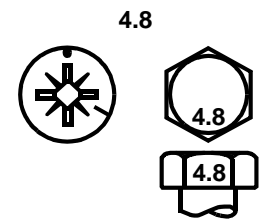
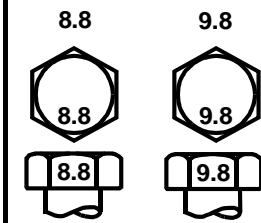
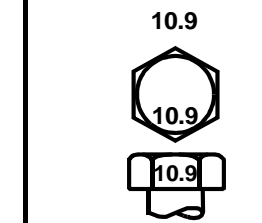
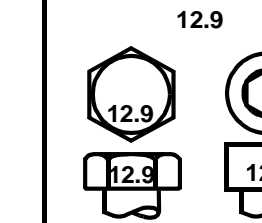
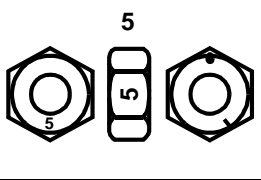
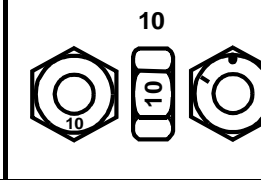
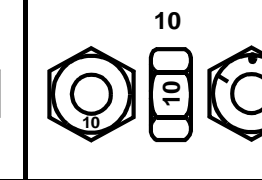
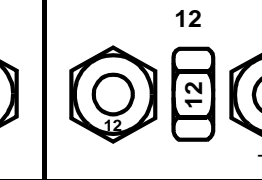
<b>Property Class and Head Markings</b>				
<b>Property Class and Nut Markings</b>				

TS1163

	Class 4.8				Class 8.8 or 9.8				Class 10.9				Class 12.9			
	Lubricated <sup>a</sup>		Dry <sup>a</sup>		Lubricated <sup>a</sup>		Dry <sup>a</sup>		Lubricated <sup>a</sup>		Dry <sup>a</sup>		Lubricated <sup>a</sup>		Dry <sup>a</sup>	
SIZE	N•m	lb-ft	N•m	lb-ft	N•m	lb-ft	N•m	lb-ft	N•m	lb-ft	N•m	lb-ft	N•m	lb-ft	N•m	lb-ft
M6	4.8	3.5	6	4.5	9	6.5	11	8.5	13	9.5	17	12	15	11.5	19	14.5
M8	12	8.5	15	11	22	16	28	20	32	24	40	30	37	28	47	35
M10	23	17	29	21	43	32	55	40	63	47	80	60	75	55	95	70
M12	40	29	50	37	75	55	95	70	110	80	140	105	130	95	165	120
M14	63	47	80	60	120	88	150	110	175	130	225	165	205	150	260	190
M16	100	73	125	92	190	140	240	175	275	200	350	225	320	240	400	300
M18	135	100	175	125	260	195	330	250	375	275	475	350	440	325	560	410
M20	190	140	240	180	375	275	475	350	530	400	675	500	625	460	800	580
M22	260	190	330	250	510	375	650	475	725	540	925	675	850	625	1075	800
M24	330	250	425	310	650	475	825	600	925	675	1150	850	1075	800	1350	1000
M27	490	360	625	450	950	700	1200	875	1350	1000	1700	1250	1600	1150	2000	1500
M30	675	490	850	625	1300	950	1650	1200	1850	1350	2300	1700	2150	1600	2700	2000
M33	900	675	1150	850	1750	1300	2200	1650	2500	1850	3150	2350	2900	2150	3700	2750
M36	1150	850	1450	1075	2250	1650	2850	2100	3200	2350	4050	3000	3750	2750	4750	3500

- DO NOT use these hand torque values if a different torque value or tightening procedure is given for a specific application. Torque values listed are for general use only and include a ± 10% variance factor. Check tightness of fasteners periodically. DO NOT use air powered wrenches.
- Shear bolts are designed to fail under predetermined loads. Always replace shear bolts with identical grade.
- Fasteners should be replaced with the same class. Make sure fastener threads are clean and that you properly start thread engagement. This will prevent them from failing when tightening.

- When bolt and nut combination fasteners are used, torque values should be applied to the **NUT** instead of the bolt head.
  - Tighten toothed or serrated-type lock nuts to the full torque value.
- <sup>a</sup> “Lubricated” means coated with a lubricant such as engine oil, or fasteners with phosphate and oil coatings. “Dry” means plain or zinc plated (yellow dichromate - Specification JDS117) without any lubrication.

Reference: JDS-200

# SPECIFICATIONS & INFORMATION SPECIFICATIONS

---







---

## Metric Fastener Torque Values - Grade 7

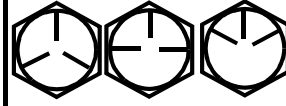
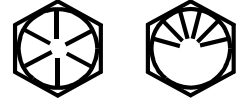
Size	Steel or Gray Iron Torque	Aluminum Torque
	N•m (lb-ft)	N•m (lb-ft)
M6	11 (8)	8 (6)
M8	24 (18)	19 (14)
M10	52 (38)	41 (30)
M12	88 (65)	70 (52)
M14	138 (102)	111 (82)
M16	224 (165)	179 (132)

# SPECIFICATIONS & INFORMATION SPECIFICATIONS

## Inch Fastener Torque Values

<b>SAE Grade and Head Markings</b>	1 or 2 <sup>b</sup> No Marks 	5    5.1    5.2 	8    8.2 
<b>SAE Grade and Nut Markings</b>	2 No Marks 	5  	8  

TS1162

SIZE	Grade 1		Grade 2 <sup>b</sup>				Grade 5, 5.1 or 5.2				Grade 8 or 8.2					
	Lubricated <sup>a</sup>		Dry <sup>a</sup>		Lubricated <sup>a</sup>		Dry <sup>a</sup>		Lubricated <sup>a</sup>		Dry <sup>a</sup>		Lubricated <sup>a</sup>		Dry <sup>a</sup>	
	N•m	lb-ft	N•m	lb-ft	N•m	lb-ft	N•m	lb-ft	N•m	lb-ft	N•m	lb-ft	N•m	lb-ft	N•m	lb-ft
1/4	3.7	2.8	4.7	3.5	6	4.5	7.5	5.5	9.5	7	12	9	13.5	10	17	12.5
5/16	7.7	5.5	10	7	12	9	15	11	20	15	25	18	28	21	35	26
3/8	14	10	17	13	22	16	27	20	35	26	44	33	50	36	63	46
7/16	22	16	28	20	35	26	44	32	55	41	70	52	80	58	100	75
1/2	33	25	42	31	53	39	67	50	85	63	110	80	120	90	150	115
9/16	48	36	60	45	75	56	95	70	125	90	155	115	175	130	225	160
5/8	67	50	85	62	105	78	135	100	170	125	215	160	215	160	300	225
3/4	120	87	150	110	190	140	240	175	300	225	375	280	425	310	550	400
7/8	190	140	240	175	190	140	240	175	490	360	625	450	700	500	875	650
1	290	210	360	270	290	210	360	270	725	540	925	675	1050	750	1300	975
1-1/8	470	300	510	375	470	300	510	375	900	675	1150	850	1450	1075	1850	1350
1-1/4	570	425	725	530	570	425	725	530	1300	950	1650	1200	2050	1500	2600	1950
1-3/8	750	550	950	700	750	550	950	700	1700	1250	2150	1550	2700	2000	3400	2550
1-1/2	1000	725	1250	925	990	725	1250	930	2250	1650	2850	2100	3600	2650	4550	3350

- DO NOT use these hand torque values if a different torque value or tightening procedure is given for a specific application. Torque values listed are for general use only and include a ± 10% variance factor. Check tightness of fasteners periodically. DO NOT use air powered wrenches.
- Shear bolts are designed to fail under predetermined loads. Always replace shear bolts with identical grade.
- Fasteners should be replaced with the same class. Make sure fastener threads are clean and that you properly start thread engagement. This will prevent them from failing when tightening.
- When bolt and nut combination fasteners are used, torque values should be applied to the **NUT** instead of

the bolt head.

- Tighten toothed or serrated-type lock nuts to the full torque value.

<sup>a</sup> “Lubricated” means coated with a lubricant such as engine oil, or fasteners with phosphate and oil coatings. “Dry” means plain or zinc plated (yellow dichromate - Specification JDS117) without any lubrication.

<sup>b</sup> “Grade 2” applies for hex cap screws (not hex bolts) up to 152 mm (6 in.) long. “Grade 1” applies for hex cap screws over 152 mm (6 in.) long, and for all other types of bolts and screws of any length.

Reference: JDS-G200

# SPECIFICATIONS & INFORMATION SPECIFICATIONS

## Face Seal Fittings with Inch Stud Ends Torque

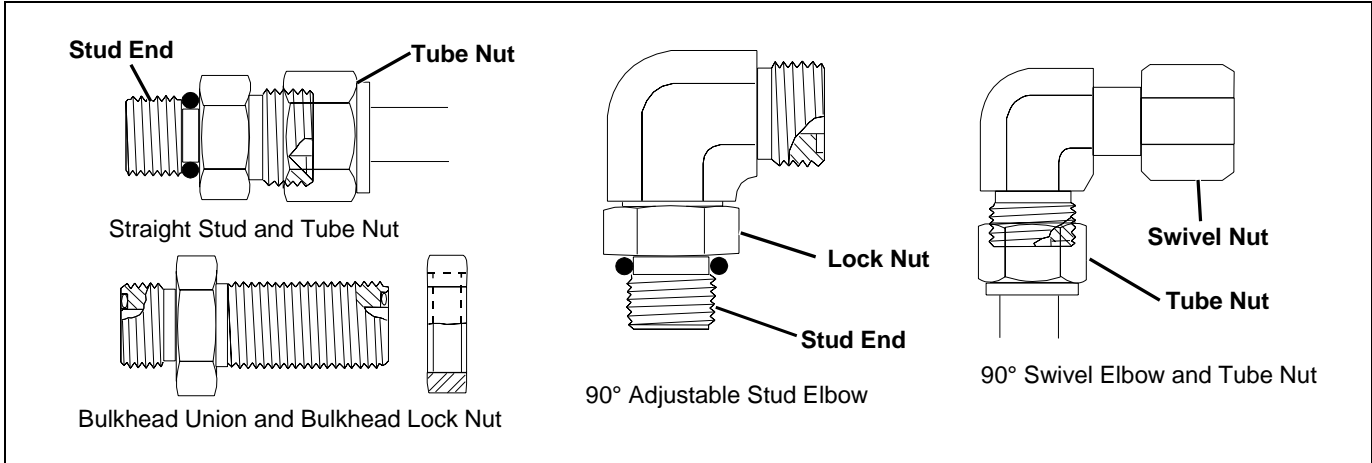

MIF

Nominal Tube OD/Hose ID				Face Seal Tube/Hose End					O-Ring Stud Ends		
Metric Tube OD	Inch Tube OD			Thread Size	Tube Nut/ Swivel Nut Torque		Bulkhead Lock Nut Torque		Thread Size	Straight Fitting or Lock Nut Torque	
	mm	Dash Size	in.		mm	in.	N•m	lb-ft		N•m	lb-ft
	-3	0.188	4.76						3/8-24	8	6
6	-4	0.250	6.35	9/16-18	16	12	12	9	7/16-20	12	9
8	-5	0.312	7.94						1/2-20	16	12
10	-6	0.375	9.52	11/16-16	24	18	24	18	9/16-18	24	18
12	-8	0.500	12.70	13/16-16	50	37	46	34	3/4-16	46	34
16	-10	0.625	15.88	1-14	69	51	62	46	7/8-14	62	46
	-12	0.750	19.05	1-3/16-12	102	75	102	75	1-1/16-12	102	75
22	-14	0.875	22.22	1-3/16-12	102	75	102	75	1-3/16-12	122	90
25	-16	1.000	25.40	1-7/16-12	142	105	142	105	1-5/16-12	142	105
32	-20	1.25	31.75	1-11/16-12	190	140	190	140	1-5/8-12	190	140
38	-24	1.50	38.10	2-12	217	160	217	160	1-7/8-12	217	160

**NOTE: Torque tolerance is +15%, -20%**

# SPECIFICATIONS & INFORMATION SPECIFICATIONS

## Face Seal Fittings with Metric Stud Ends Torque

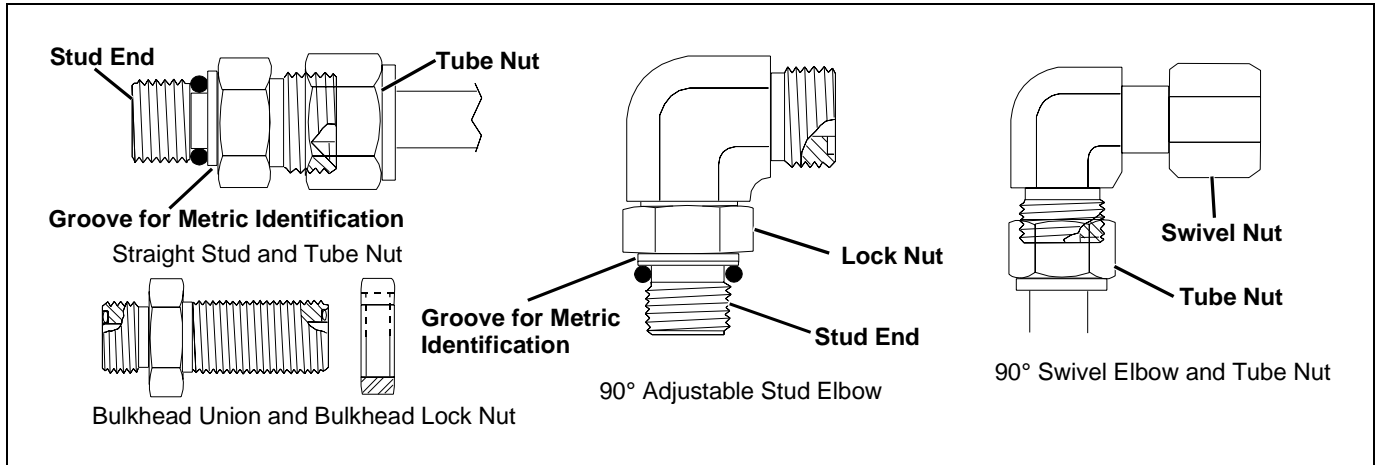

MIF

Nominal Tube OD/Hose ID				Face Seal Tube/Hose End						O-Ring Stud Ends, Straight Fitting or Lock Nut					
Metric Tube OD	Inch Tube OD			Thread Size	Hex Size	Tube Nut/ Swivel Nut Torque		Bulkhead Lock Nut Torque		Thread Size	Hex Size	Steel or Gray Iron Torque		Aluminum Torque	
	mm	Dash Size	in.			mm	in.	mm	N•m			lb-ft	N•m	lb-ft	mm
6	-4	0.250	6.35	9/16-18	17	16	12	12	9	M12X1.5	17	21	15.5	9	6.6
8	-5	0.312	7.94							M14X1.5	19	33	24	15	11
10	-6	0.375	9.52	11/16-16	22	24	18	24	18	M16X1.5	22	41	30	18	13
12	-8	0.500	12.70	13/16-16	24	50	37	46	34	M18X1.5	24	50	37	21	15
16	-10	0.625	15.88	1-14	30	69	51	62	46	M22X1.5	27	69	51	28	21
	-12	0.750	19.05	1-3/16-12	36	102	75	102	75	M27X2	32	102	75	46	34
22	-14	0.875	22.22	1-3/16-12	36	102	75	102	75	M30X2	36				
25	-16	1.000	25.40	1-7/16-12	41	142	105	142	105	M33X2	41	158	116	71	52
28										M38X2	46	176	130	79	58
32	-20	1.25	31.75	1-11/16-12	50	190	140	190	140	M42X2	50	190	140	85	63
38	-24	1.50	38.10	2-12	60	217	160	217	160	M48X2	55	217	160	98	72

**NOTE: Torque tolerance is +15%, -20%**

# SPECIFICATIONS & INFORMATION SPECIFICATIONS

## O-Ring Face Seal Fittings

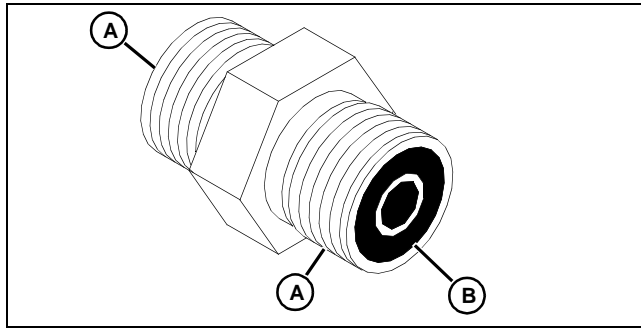

1. Inspect the fitting sealing surfaces (A). They must be free of dirt or defects.
2. Inspect the O-ring (B). It must be free of damage or defects.
3. Lubricate O-rings and install into groove using petroleum jelly to hold in place.
4. Push O-ring into the groove with plenty of petroleum jelly so O-ring is not displaced during assembly.
5. Index angle fittings and tighten by hand-pressing joint together to ensure O-ring remains in place.

**IMPORTANT: Avoid damage! DO NOT allow hoses to twist when tightening fittings. Use two wrenches to tighten hose connections; one to hold the hose, and the other to tighten the swivel fitting.**

6. Tighten fitting or nut to torque value shown on the chart per dash size stamped on the fitting.

## O-Ring Boss Fittings

1. Inspect O-ring boss seat. It must be free of dirt and defects. If repeated leaks occur, inspect for defects with a magnifying glass. Some raised defects can be removed with a slip stone.

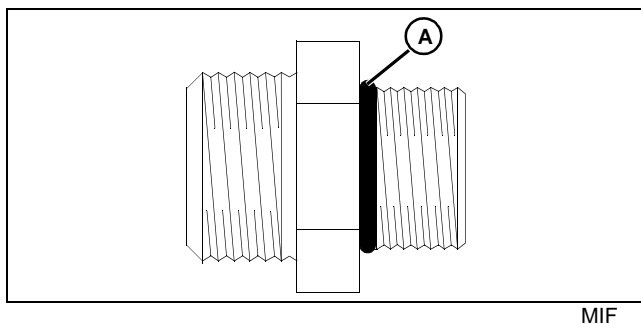

2. Put hydraulic oil or petroleum jelly on the O-ring (A). Place electrical tape over the threads to protect O-ring from nicks. Slide O-ring over the tape and into the groove of fitting. Remove tape.

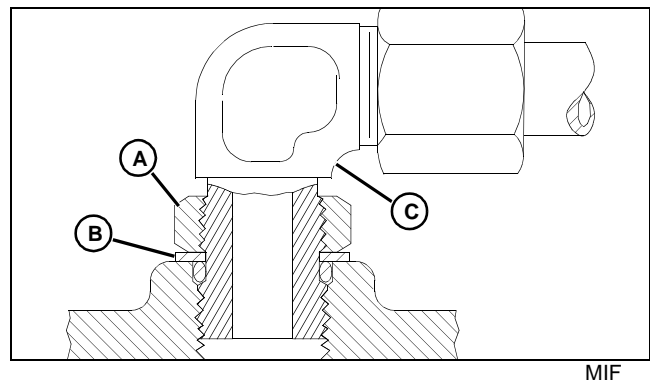

3. For angle fittings, loosen special nut (A) and push special washer (B) against threads so O-ring can be installed into the groove of fitting.
4. Turn fitting into the boss by hand until special washer or washer face (straight fitting) contacts boss face and O-ring is squeezed into its seat.
5. To position angle fittings (C), turn the fitting counter-clockwise a maximum of one turn.
6. Tighten straight fittings to torque value shown on chart. For angle fittings, tighten the special nut to value shown in the chart while holding body of fitting with a wrench.

Thread Size	Torque <sup>a</sup>		Number of Flats <sup>bb</sup>
	N•m	lb-ft	
3/8-24 UNF	8	6	2
7/16-20 UNF	12	9	2
1/2-20 UNF	16	12	2
9/16-18 UNF	24	18	2
3/4-16 UNF	46	34	2
7/8-14 UNF	62	46	1-1/2
1-1/16-12 UN	102	75	1
1-3/16-12 UN	122	90	1
1-5/16-12 UN	142	105	3/4
1-5/8-12 UN	190	140	3/4
1-7/8-12 UN	217	160	1/2

*a. Torque tolerance is  $\pm 10$  percent.*

*b. To be used if a torque wrench cannot be used. After tightening fitting by hand, put a mark on nut or boss; then tighten special nut or straight fitting the number of flats shown.*

# SPECIFICATIONS & INFORMATION SPECIFICATIONS

## Diesel Fuel



**CAUTION: Avoid injury! California Proposition 65 Warning: Diesel engine exhaust and some of its elements from this product are known to the State of California to cause cancer, birth defects, or other reproductive harm.**

In general, diesel fuels are blended to satisfy the low air temperature requirements of the geographical area in which they are sold.

In North America, diesel fuel is usually specified to **ASTM D975** and sold as either **Grade 1** for cold air temperatures or **Grade 2** for warm air temperatures.

If diesel fuels being supplied in your area **DO NOT** meet any of the above specifications, use diesel fuels with the following equivalent properties:

- **Cetane Number 40 (minimum)**

A cetane number **greater than 50 is preferred**, especially for air temperatures below -20°C (-4°F) or elevations above 1500 m (5000 ft).

- **Cold Filter Plugging Point (CFPP)**

The temperature at which diesel fuel **begins to cloud or jell**. Use diesel fuels with a CFPP which is at least 5°C (9°F) below the expected low air temperature range.

- **Sulfur Content of 0.05% (maximum)**

Diesel fuels for highway use in the United States now require sulfur content to be **less than 0.05%**.

If diesel fuel being used has a sulfur content **greater than 0.05%**, **reduce the service interval for engine oil and filter by 50%**.

Consult your local diesel fuel distributor for properties of the diesel fuel available in your area.

## Diesel Fuel Lubricity

Diesel fuel must have adequate lubricity to ensure proper operation and durability of fuel injection system components. Fuel lubricity should pass a **minimum of 3300 gram load level** as measured by the **BOCLE** scuffing test.

## Diesel Fuel Storage

**IMPORTANT: Avoid damage! DO NOT USE GALVANIZED CONTAINERS - diesel fuel stored in galvanized containers reacts with zinc coating in the container to form zinc flakes. If fuel contains water, a zinc gel will also form. The gel and flakes will quickly plug fuel filters and damage fuel injectors and fuel pumps.**

It is recommended that diesel fuel be stored **ONLY** in a clean, approved **POLYETHYLENE PLASTIC** container **WITHOUT** any metal screen or filter. This will help prevent any accidental sparks from occurring. Store fuel in an area that is well ventilated to prevent possible igniting of fumes by an open flame or spark, this includes any appliance with a pilot light.

**IMPORTANT: Avoid damage! Keep all dirt, scale, water or other foreign material out of fuel.**

Keep fuel in a safe, protected area and in a clean, properly marked (“**DIESEL FUEL**”) container. **DO NOT** use de-icers to attempt to remove water from fuel. **DO NOT** depend on fuel filters to remove water from fuel. It is recommended that a water separator be installed in the storage tank outlet. **BE SURE** to properly discard unstable or contaminated diesel fuel and/or their containers when necessary.

## DIESELSCAN™ Fuel Analysis

DIESELSCAN is a John Deere fuel sampling program to help you monitor the quality of your fuel source. It verifies fuel type, cleanliness, water content, suitability for cold weather operation, and if fuel is within ASTM specifications. Check with your John Deere dealer for availability of DIESELSCAN kits.

# SPECIFICATIONS & INFORMATION SPECIFICATIONS

## Engine Oil

Use the appropriate oil viscosity based on the expected air temperature range during the period between recommended oil changes. Operating outside of these recommended oil air temperature ranges may cause premature engine failure.

The following John Deere oils are PREFERRED:

- TORQ-GARD SUPREME® - SAE 5W-30;
- PLUS-50® - SAE 15W-40;

Other oils may be used if above John Deere oils are not available, provided they meet one of the following specifications:

- SAE 15W-40 - API Service Classification CH-4 or higher;
- SAE 10W-30 - API Service Classification CG-4 (4-cycle) or higher;

**John Deere Dealers:** You may want to cross-reference the following publications to recommend the proper oil for your customers:

- Module DX,ENOIL2 in JDS-G135;
- Section 530, Lubricants & Hydraulics, of the John Deere Merchandise Sales Guide;
- Lubrication Sales Manual PI7032.

## Engine Break-in Oil

**IMPORTANT: Avoid damage! ONLY use a quality break-in oil in rebuilt or remanufactured engines for the first 5 hours (maximum) of operation. DO NOT use oils with heavier viscosity weights than SAE 5W-30 or oils meeting specifications API SG or SH; these oils will not allow rebuilt or remanufactured engines to break-in properly.**

The following John Deere oil is PREFERRED:

- BREAK-IN ENGINE OIL

John Deere BREAK-IN ENGINE OIL is formulated with special additives for aluminum and cast iron type engines to allow the power cylinder components (pistons, rings, and liners as well) to “wear-in” while protecting other engine components, valve train and gears, from abnormal wear. Engine rebuild instructions should be followed closely to determine if special requirements are necessary.

John Deere BREAK-IN ENGINE OIL is also recommended for non-John Deere engines, both aluminum and cast iron types.

The following John Deere oil is **also recommended as a break-in engine oil:**

- TORQ-GARD SUPREME® - SAE 5W-30.

If the above recommended John Deere oil is not available, use a break-in engine oil meeting the following specification during the first 5 hours (maximum) of operation:

- SAE 5W-30 - API Service Classification SE or higher.

**IMPORTANT: Avoid damage! After the break-in period, use the John Deere oil that is recommended for this engine.**

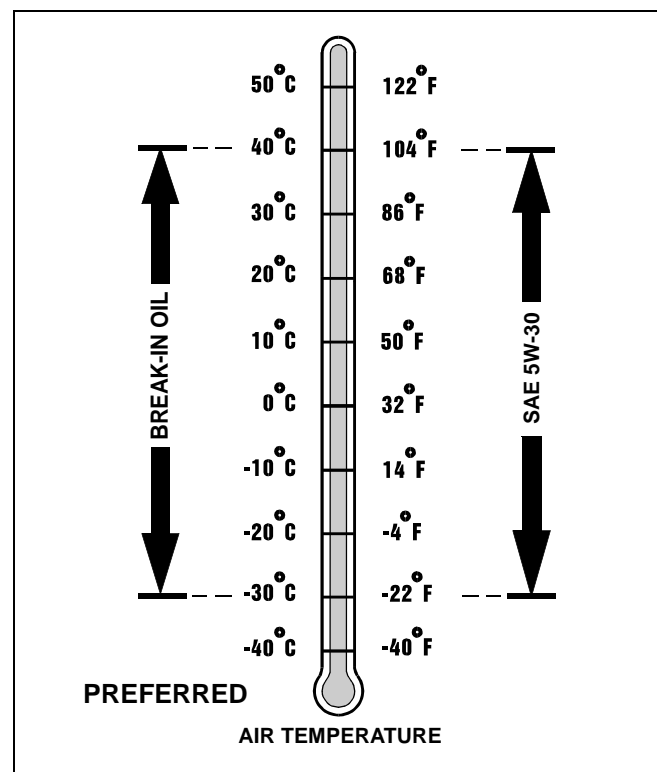

M58275

**John Deere Dealers:** You may want to cross-reference the following publications to recommend the proper oil for your customers:

- Module DX,ENOIL4 in JDS-G135;
- Section 530, Lubricants & Hydraulics, of the John Deere Merchandise Sales Guide;
- Lubrication Sales Manual PI7032.

## OILSCAN®, OILSCAN Plus®, COOLSCAN™, and COOLSCAN PLUS™



T104220

OILSCAN, OILSCAN Plus, COOLSCAN, and COOLSCAN PLUS are John Deere sampling fluid programs to help you monitor machine maintenance and system condition. The objective of a fluid sampling program is to ensure machine availability when you need it and to reduce repair costs by identifying potential problems before they become critical.

Oil and coolant samples should be taken from each system prior to its recommended change interval.

Check with your John Deere dealer on a maintenance program for your specific application. Your dealer has the sampling products and expertise to assist you in lowering your overall operating costs through fluid sampling.

### Alternative Lubricants

Conditions in certain geographical areas outside the United States and Canada may require different lubricant recommendations than the ones printed in this technical manual or the operator's manual. Consult with your John Deere Dealer, or Sales Branch, to obtain the alternative lubricant recommendations.

**IMPORTANT: Avoid damage! Use of alternative lubricants could cause reduced life of the component.**

If alternative lubricants are to be used, it is recommended that the factory fill be thoroughly removed before switching to any alternative lubricant.

### Synthetic Lubricants

Synthetic lubricants may be used in John Deere equipment if they meet the applicable performance requirements (industry classification and/or military specification) as shown in this manual.

The recommended air temperature limits and service or lubricant change intervals should be maintained as shown in the operator's manual.

Avoid mixing different brands, grades, or types of oil. Oil manufacturers blend additives in their oils to meet certain specifications and performance requirements. Mixing different oils can interfere with the proper functioning of these additives and degrade lubricant performance.

### Lubricant Storage

All machines operate at top efficiency only when clean lubricants are used. Use clean storage containers to handle all lubricants. Store them in an area protected from dust, moisture, and other contamination. Store drums on their sides. Make sure all containers are properly marked as to their contents. Dispose of all old, used containers and their contents properly.

### Mixing of Lubricants

In general, avoid mixing different brands or types of lubricants. Manufacturers blend additives in their lubricants to meet certain specifications and performance requirements. Mixing different lubricants can interfere with the proper functioning of these additives and lubricant properties which will downgrade their intended specified performance.

# SPECIFICATIONS & INFORMATION SPECIFICATIONS

## Chassis Grease

Use the following grease based on the air temperature range. Operating outside of the recommended grease air temperature range may cause premature failures.

The following John Deere grease is **PREFERRED**:

- **John Deere Moly High Temperature EP Grease**

If not using the preferred grease, be sure to use a general all-purpose grease with an NLGI grade No. 2 rating.

Wet or high speed conditions may require use of a special-use grease. Contact your Servicing dealer for information.

**John Deere Dealers:** You may want to cross-reference the following publications to recommend the proper grease for your customers:

- Module DX,GREA1 in JDS-G135;
- Section 530, Lubricants & Hydraulics, of the John Deere Merchandise Sales Guide;
- Lubrication Sales Manual P17032.

## Transaxle Oil

These tractors are equipped with an internal wet disc brake transmission.

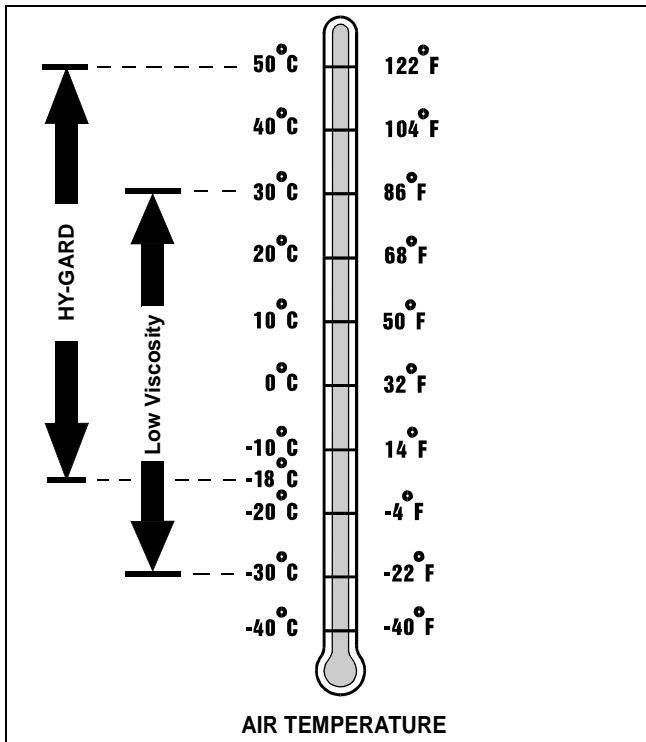

**IMPORTANT: Avoid damage! Transaxle is filled with John Deere HY-GARD® (J20C) transmission oil at the factory. DO NOT mix oils**

Do not use type "F" automatic transmission fluid.

Use only HY-GARD (J20C) or Low Viscosity HY-GARD (J20D) transmission oil.

John Deere HY-GARD transmission oil is specially formulated to provide maximum protection against mechanical wear, corrosion, and foaming.

The following John Deere oil is **PREFERRED**:

- **HY-GARD J20C Oil**

The following oil is also recommended if above preferred oil is not available:

- **Low Viscosity HY-GARD J20D Oil**

**IMPORTANT: Avoid damage! If operating temperatures are below -18°C (0°F), you must use Low Viscosity HY-GARD or transmission damage will occur.**

Use the appropriate oil viscosity based on the air temperature ranges. Operating outside of these recommended oil air temperature ranges may cause premature gear case failure.

**John Deere Dealers:** You may want to cross-reference the following publications to recommend the proper oil for your customers:

- Module DX,ENOIL2 in JDS-G135;
- Section 530, Lubricants & Hydraulics, of the John Deere Merchandise Sales Guide;
- Lubrication Sales Manual PI7032.

# SPECIFICATIONS & INFORMATION SPECIFICATIONS

## Engine Coolant

The engine cooling system, when filled with a proper dilution mixture of anti-freeze and deionized or distilled water, provides year-round protection against corrosion, cylinder or liner pitting, and winter freeze protection down to -37°C (-34°F).

The following John Deere coolant is **PREFERRED**:

- PRE-DILUTED DIESEL ENGINE ANTI-FREEZE/SUMMER COOLANT™ (TY16036).

This coolant satisfies specifications for “Automobile and Light Duty Engine Service” and is safe for use in John Deere Lawn and Grounds Care/Golf and Turf Division equipment, including aluminum block gasoline engines and cooling systems.

The above preferred pre-diluted anti-freeze provides:

- adequate heat transfer
- corrosion-resistant chemicals for the cooling system
- compatibility with cooling system hose and seal material
- protection during extreme cold and extreme hot weather operations
- chemically pure water for better service life
- compliance with ASTM D4656 (JDM H24C2) specifications

If above preferred pre-diluted coolant is not available, the following John Deere concentrate is **recommended**:

- DIESEL ENGINE ANTI-FREEZE/SUMMER COOLANT CONCENTRATE™ (TY16034).

If either of above recommended engine coolants are not available use any Automobile and Light Duty Engine Service **ethylene glycol base coolant**, meeting the following specification:

- ASTM D3306 (JDM H24C1).

Read container label completely before using and follow instructions as stated.

**IMPORTANT: Avoid damage! To prevent engine damage, DO NOT use pure anti-freeze or less than a 50% anti-freeze mixture in the cooling system. DO NOT mix or add any additives/conditioners to the cooling system in Lawn and Grounds Care/Golf and Turf Division equipment. Water used to dilute engine coolant concentrate must be of high quality - clean, clear, potable water (low in chloride and hardness - Table 1) is generally acceptable. DO NOT use salt water. Deionized or distilled water is ideal to use. Coolant that is not mixed to these specified levels and water purity can cause excessive scale, sludge deposits, and increased corrosion potential.**

Property	Requirements
Total Solids, Maximum	340 ppm (20 grns/gal)
Total Hardness, Max.	170 ppm (10 grns/gal)
Chloride (as Cl), Max.	40 ppm (2.5 grns/gal)
Sulfate (as SO <sub>4</sub> ), Max.	100 ppm (5.8 grns/gal)

Mix 50 percent anti-freeze concentrate with 50 percent distilled or deionized water. This mixture and the prediluted mixture (TY16036) will protect the cooling system down to -37°C (-34°F) and up to 108°C (226°F).

Certain geographical areas may require lower air temperature protection. See the label on your anti-freeze container or consult your John Deere dealer to obtain the latest information and recommendations.

# SPECIFICATIONS & INFORMATION SPECIFICATIONS

## Testing Diesel Engine Coolant

Maintaining adequate concentrations of glycol and inhibiting additives in the coolant is critical to protect the engine and cooling system against freezing, corrosion, and cylinder liner erosion and pitting.

Test the coolant solution at intervals of 12 months or less and whenever excessive coolant is lost through leaks or overheating.

### Coolant Test Strips



RG7297

Picture Note: Coolant Test Strips



RG7397

Picture Note: COOLSCAN Bellows

Coolant test strips are available from your John Deere dealer. These test strips provide a simple, effective method to check the freeze point and additive levels of your engine coolant.

Compare the results to the supplemental coolant additive (SCA) chart to determine the amount of inhibiting additives in your coolant and whether more John Deere coolant conditioner should be added.

### COOLSCAN™ and COOLSCAN PLUS™

For a more thorough evaluation of your coolant, perform a COOLSCAN or COOLSCAN PLUS analysis. See your John Deere dealer for information.

## Operating in Warm Temperature Climates

These engines are designed to operate using glycol base engine coolants.

Always use a recommended glycol base engine coolant, even when operating in geographical areas where freeze protection is not required.

**IMPORTANT: Avoid damage! Water may be used as coolant in emergency situations only.**

**Foaming, hot surface aluminum and iron corrosion, scaling, and cavitation will occur when water is used as the coolant, even when coolant conditioners are added.**

**Drain cooling system and refill with recommended glycol base engine coolant as soon as possible.**

## Flush and Service Cooling System



TS281



**CAUTION:** Avoid injury! Explosive release of fluids from pressurized cooling system can cause serious burns. Shut off engine. Remove filler cap only when cool enough to touch with bare hands. Slowly loosen cap to first stop to relieve pressure before removing cap completely.

**IMPORTANT:** Avoid damage! Air must be expelled from cooling system when system is refilled. Follow procedure given in your operator's manual.

Whenever the aluminum timing gear cover or coolant pump are replaced, the cooling system should be completely drained. In addition to opening petcock on radiator, remove lower radiator hose when draining cooling system.

The ethylene glycol base (antifreeze) can become depleted of SCAs, allowing various acids to form that will damage engine components. In addition, heavy metals, such as lead, copper, and zinc, accumulate in the ethylene glycol base. The heavy metals come from corrosion that occurs to some degree within a cooling system. When a coolant is saturated to the point where it can no longer hold heavy metals and other dissolved solids, they settle out and act as abrasives on engine parts.

**NOTE:** Refer to your operator's manual for specific service interval.

Flush cooling system as described in your operator's manual. Clean cooling system with clean water and a cleaner such as FLEETGUARD® RESTORE™ or RESTORE PLUS™. Follow the instructions provided with the cleaner. Refill cooling system with the appropriate coolant solution. See "Engine Coolant" on page 19.

**IMPORTANT:** Avoid damage! NEVER overfill the system. A pressurized system needs space for heat expansion without overflowing at the top of the radiator. Coolant level should be at bottom of radiator filler neck.

Air must be expelled from cooling system when system is refilled. Loosen plug in side of thermostat housing to allow air to escape when filling system. Retighten plug when all the air has been expelled.

After adding new coolant solution, run engine until it reaches operating temperature. This mixes the coolant solution uniformly and circulates it through the entire system. After running engine, check coolant level and entire cooling system for leaks.

Contact your engine servicing dealer, if there are further questions.

## Disposing of Coolant

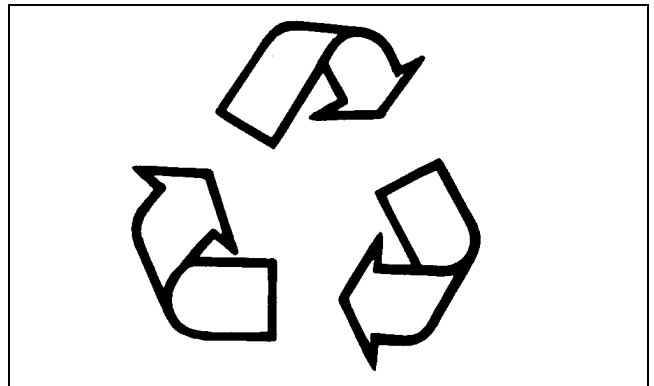

TS1133

Improperly disposing of engine coolant can threaten the environment and ecology.

Use leakproof containers when draining fluids. Do not use food or beverage containers that may mislead someone into drinking from them.

Do not pour waste onto ground, down a drain, or into any water source.

Inquire on the proper way to recycle or dispose of waste from your local government or recycling center, or from your engine servicing dealer.

# SPECIFICATIONS & INFORMATION SPECIFICATIONS

## Engine Coolant Drain Interval

When using **John Deere Pre-Diluted (TY16036)** Automobile and Light Duty Engine Service coolants, drain and flush the cooling system and refill with fresh coolant mixture every **36 months or 3,000 hours** of operation, whichever comes first.

When using **John Deere Concentrate (TY16034)** Automobile and Light Duty Engine Service coolants, drain and flush the cooling system and refill with fresh coolant mixture every **24 months or 2,000 hours** of operation, whichever comes first.

If above John Deere Automobile and Light Duty Engine Service coolants **are not** being used, drain, flush, and refill the cooling system according to instructions found on product container or in equipment operator's manual or technical manual.

## Machine Product Identification Number

When ordering parts or submitting a warranty claim, it is **IMPORTANT** that the machine product identification number (PIN) and component serial numbers are included. The location of the PIN and component serial numbers are shown.



MX14749

Located on right-hand side of frame.

## Engine Serial Number Location

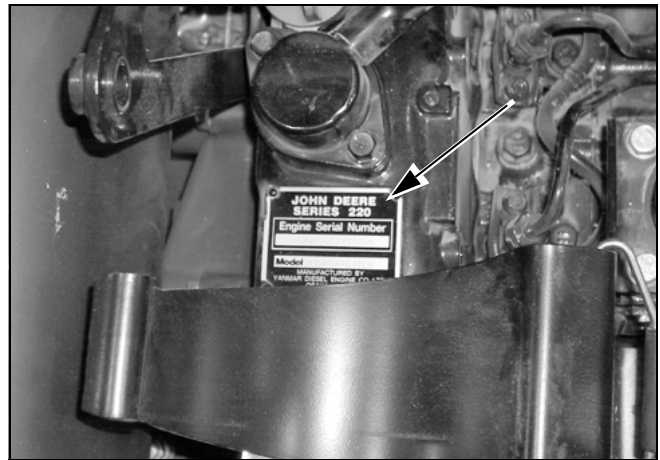

MX14750

**Picture Note: Air Cleaner Removed for Clarity**

Located on top of engine.

# SPECIFICATIONS & INFORMATION GENERAL INFORMATION

## General Information

### Interlock System

It is important to understand the interlock system and how it works. Before performing the checkout procedures, become familiar with the interlock system so that an interlock function will not be mistaken for a machine problem.

In order to operate PTO driven attachments, the following conditions must occur:

- Operator sitting on operator seat.
- Throttle lever moved to the desired position.
- Park brake not engaged.
- PTO switch in the ON position.

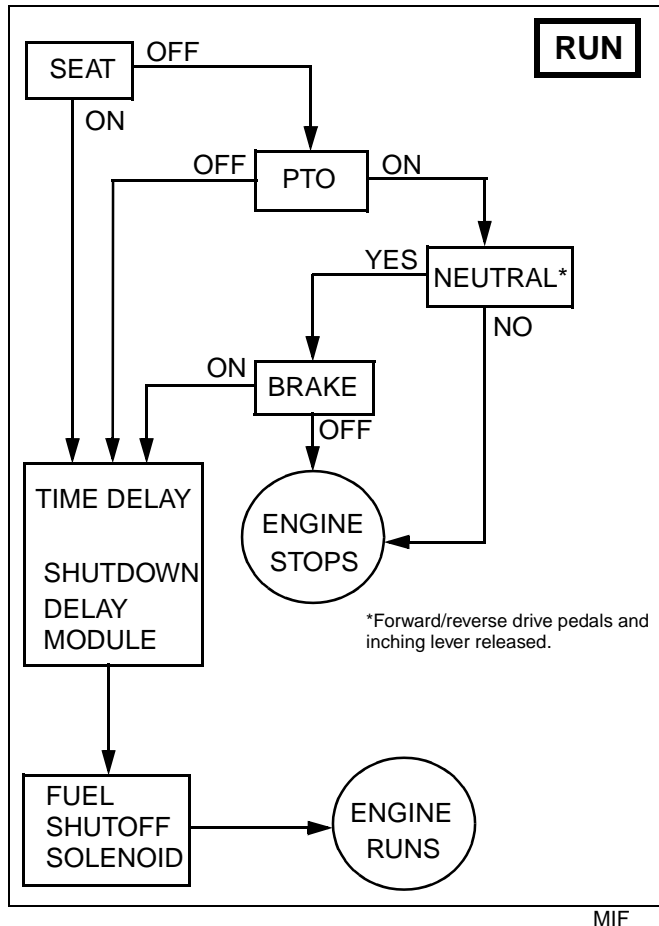

For the engine to run, one of the following must occur:

- Operator must be on the seat when the PTO is engaged and the park brake is disengaged.
- When operator is NOT on the seat, if the PTO is engaged, the park brake MUST BE engaged with the transmission in neutral position<sup>1</sup>.

If the operator is operating a PTO driven attachment and rises off the seat, the attachment and engine will stop.

1. Forward/reverse drive pedals and inching lever in neutral position.



# ENGINE-DIESEL TABLE OF CONTENTS

## Table of Contents

<b>Specifications .....27</b>	<b>Bleed Fuel System ..... 55</b>
General Specifications .....27	<b>Repair..... 55</b>
Repair Specifications.....27	Engine Removal/Installation ..... 55
Tests and Adjustment Specifications .....31	Rocker Cover Removal/Installation ..... 56
Torque Values, Non-Standard	Exhaust Manifold Removal/Installation.... 57
Fasteners .....32	Intake Manifold Removal/Installation..... 57
<b>Tools and Materials .....33</b>	Rocker Arm Assembly Repair ..... 58
Special Tools.....33	Cylinder Head and Valves Repair ..... 60
Other Materials.....33	Piston and Connecting Rod ..... 66
<b>Theory of Operation .....34</b>	Cylinder Bore..... 72
Cooling System Operation .....34	Crankcase Extension Housing
Lubrication System Operation .....35	Removal/Installation ..... 74
Fuel System Operation.....36	Balancer Assembly Repair ..... 74
Air Intake System Operation .....36	Crankshaft Rear Oil Seal Replacement... 75
<b>Diagnostics .....37</b>	Crankshaft Front Oil Seal Replacement.. 76
Engine Exterior.....37	Crankshaft and Main Bearings Repair..... 76
Engine Oil/Lubrication System .....37	Flywheel Removal/Installation ..... 79
Air Intake System .....37	Flywheel Housing Removal/Installation... 80
Cooling System .....37	Camshaft Removal/Installation..... 80
Fuel System .....38	Cam Follower Repair ..... 83
Engine Performance .....40	Timing Gear Cover Removal/Installation. 84
<b>Tests and Adjustments .....40</b>	Idle Gear Repair ..... 85
Cylinder Compression Test.....40	Timing Gear Cover Mounting Plate
Slow Idle Adjustment.....41	Removal/Installation ..... 86
Valve Clearance Check and Adjustment..42	Oil Pan and Strainer
Connecting Rod Side Play Check .....43	Removal/Installation ..... 86
Connecting Rod Bearing	Oil Pump Repair ..... 86
Clearance Check.....43	Thermostat and Water Pump
Crankshaft End Play Check .....44	Disassembly ..... 87
Crankshaft Main Bearing	Radiator/Oil Cooler Assembly
Clearance Check.....45	Removal/Installation ..... 88
Valve Lift Check .....46	Fuel Supply Component Location ..... 89
Camshaft End Play Check .....46	Fuel Injection Pump
Timing Gear Backlash Check.....47	Removal/Installation ..... 91
Fuel Injection Nozzle Test.....47	Fuel Injection Nozzle Repair..... 93
Thermostat Opening Test.....49	Fuel Filter Assembly ..... 95
Injection Pump Static Timing Adjustment.50	Starting Motor Component Location..... 96
Fan/Alternator Drive Belt Adjustment.....51	Starting Motor Repair ..... 96
Cylinder Leakdown Test.....52	Alternator Repair ..... 102
Cooling System Pressure Test.....52	Alternator Component Location..... 106
Radiator Cap Pressure Test.....53	
Engine Oil Pressure Test .....53	
Fuel Transfer Pump Pressure Test .....54	
Fuel System Leakage Test.....54	

# ENGINE-DIESEL TABLE OF CONTENTS

Product: John Deere 110 Loader Backhoe Tractor Service Repair Technical Manual

Full Download: <https://www.bobmanualstore.com/downloads/john-deere-110-loader-backhoe-tractor-service-repair-technical-manual/>

Sample manual. Download All 540 pages at:

<https://www.bobmanualstore.com/downloads/john-deere-110-loader-backhoe-tractor-service-repair-technical-manual/>