

Product: John Deere 140 Hydrostatic Tractor Service Repair Technical Manual  
Full Download: <https://www.bobmanualstore.com/downloads/john-deere-140-hydrostatic-tractor-service-repair-technical-manual/>

# **140 HYDROSTATIC TRACTOR**

**(Serial No. 30,001- ..**  
**Service Manual**  
**SM-2093-(Jul-73)**

**John Deere Horicon Works**  
**SM2093 (JUL-73)**  
LITHO IN U.S.A.  
**ENGLISH**

Sample manual. Download All 227 pages at:  
<https://www.bobmanualstore.com/downloads/john-deere-140-hydrostatic-tractor-service-repair-technical-manual/>

# 140 HYDROSTATIC TRACTOR

(Serial No. 30,001- )

## Service Manual

### SM-2093-(Jul-73)

#### CONTENTS

##### SECTION 10 - GENERAL

- Group 5 - Tractor Identification
- Group 10 - Specifications
- Group 15 - Tune-up and Adjustment
- Group 20 - Fuel and Lubricants

##### SECTION 20 - ENGINE

- Group 5 - General Information
- Group 10 - Cylinder Head, Valves and Breather
- Group 15 - Piston, Crankshaft, Main Bearings, Balance Gears, and Flywheel
- Group 20 - Camshaft, Tappets, and Governor

##### SECTION 30 - FUEL SYSTEM

- Group 5 - General Information
- Group 10 - Carburetor
- Group 15 - Air Cleaner
- Group 20 - Fuel Strainer and Gas Tank

##### SECTION 40 - ELECTRICAL SYSTEM

- Group 5 - General Information
- Group 10 - Cranking System
- Group 15 - Ignition System
- Group 20 - Charging System
- Group 25 - PTO Clutch, Lights and Accessories

##### SECTION 50 - POWER TRAIN

- Group 5 - General Information
- Group 10 - Clutch, Neutral-Return and Drive Shaft H-1 (Serial No. 30,001-38,000) and H-3 (Serial No. 30,001-46,883)
- Group 11 - Neutral Return and Drive Shaft H-1 (Serial No. 38,001- ) and H-3 (Serial No. 46,884- )
- Group 12 - Brakes
- Group 15 - Hydrostatic Transmission
- Group 20 - Control Cam and Linkage
- Group 25 - Differential and Axle

##### SECTION 60 - HYDRAULIC LIFT SYSTEM

- Group 5 - General Information
- Group 10 - Hydraulic Circuits
- Group 15 - Hydraulic Control Valves
- Group 20 - Hydraulic Cylinders

##### SECTION 70 - MISCELLANEOUS

- Group 5 - General Information
- Group 10 - Steering Assembly
- Group 15 - Front Wheels and Axle (Serial No. 30,001-38,000)
- Group 16 - Front Wheels and Axle (Serial No. 38,001- )
- Group 20 - Fender-Deck and Seat Assembly

*(All information, illustrations and specifications contained in this service manual are based on the latest information available at the time of publication. The right is reserved to make changes at any time without notice.)*

Sample manual (Download All 227 pages at: <https://www.bobmanualstore.com/downloads/john-deere-140-hydrostatic-tractor-service-repair-technical-manual/>)

Litho in U.S.A.

Copyright © 1970  
DEERE & COMPANY  
Moline, Illinois  
All rights reserved

## INTRODUCTION

This service manual contains service and maintenance information for the John Deere 140 Hydrostatic Tractor, (Serial No. 30,001- ).

The manual is divided into sections. Each section pertains to a certain component or operational system of the tractor. The information is divided into groups within each section.

All sections of this service manual should be carefully studied by the serviceman. Much basic information such as the principles of 4-cycle engine operation, carburetion and ignition can be found in any good library and is recommended reading for the new serviceman before consulting this manual for service procedures.

Emphasis is placed on diagnosing malfunctions, analysis and testing. Diagnosing malfunctions in-

cludes possible troubles, their causes and how to correct them. Under specific components these troubles are analyzed to help the serviceman understand what is causing the problem. In this way, he can eliminate the cause rather than just replace parts and have the same problem keep recurring.

Specifications and special tools are found at the end of the Groups for easy reference.

This manual can be kept in its own cover, or it can be removed and filed in your service manual rack or placed behind the service manual tab in your Consumer Products Parts and Service Binder.

Whenever new or revised pages are provided, insert them into your manual as soon as you receive them. Your service manual will always be up-to-date and be a valuable asset in your service department.



This safety alert symbol identifies important safety messages in this manual. When you see this symbol, be alert to the possibility of personal injury and carefully read the message that follows.

# Section 10 GENERAL

## Group 5 TRACTOR IDENTIFICATION

### TABLE OF CONTENTS

	Page		Page
<b>GROUP 5 - TRACTOR IDENTIFICATION</b>		<b>GROUP 15 - TUNE-UP AND ADJUSTMENT</b>	
Serial Numbers .....	5-2	Preliminary Engine Testing .....	15-1
Identification Codes .....	5-2	Minor Tune-Up Guide .....	15-1
Tractor Codes .....	5-2	Major Tune-Up Guide .....	15-2
Tire Codes .....	5-2	Common Adjustments .....	15-2
Hydraulic System Codes .....	5-2		
<b>GROUP 10 - SPECIFICATIONS</b>		<b>GROUP 20 - FUEL AND LUBRICANTS</b>	
Engine Specifications .....	10-1	Fuel .....	20-1
Capacities .....	10-1	Lubricants .....	20-1
Tractor Specifications .....	10-2	Capacities .....	20-1
Bolt Torque Chart .....	10-3	Type of Lubricant .....	20-2
Set Screw Seating Torque Chart .....	10-3	Service Intervals .....	20-2
Rear Wheel Weight Bolt Size Chart .....	10-4	Changing Crankcase Oil .....	20-2
		Changing Hydrostatic Drive Filter .....	20-3
		Changing Hydrostatic Drive Oil .....	20-3
		Grease Fitting Locations .....	20-4

## SERIAL NUMBERS

Each 140 Hydrostatic Tractor is assigned an individual serial number. This number is found below the instrument panel assembly.

Below is a typical serial number plate from a 140 Tractor.

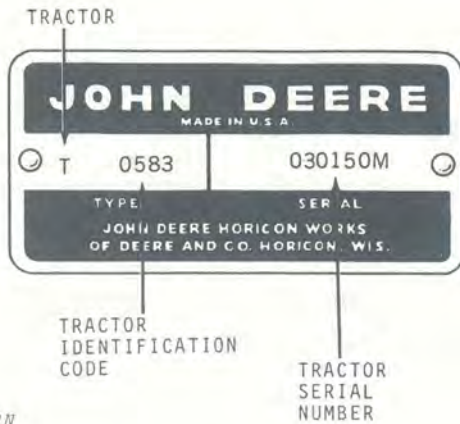

M9382N

Fig. 1-Serial Number Plate

## IDENTIFICATION CODES

### Tractor Codes

Six tractor codes are used for the 140 Tractor and they refer to base color and type of hydraulic system.

Base Color	Type Hydraulics	Serial Number	
		Tractor Code	Tractor No.
Green	H-1	T0581	030001
White	H-1	T0582	030001
Green	H-3	T0583	030001
White	H-3	T0584	030001
Green	H-1	T0585	046501
Green	H-3	T0586	046501

## Tire Codes

John Deere 140 Tractors are available with five different combinations of tires as follows:

Tire Code	Size Front	Size Rear	Tubeless	PR*	Tread
GT-3	16x6.50-8	23x8.50-12	Yes	2	High-Flotation
GT-4	4.80/4.00-8 -----	-----	No	4	Studded
		23x8.50-12	Yes	2	Traction
GT-5	16x16.50-8	23x10.50-12	Yes	2	High-Flotation
GT-6	16x6.50-8 -----	-----	Yes	2	High-Flotation
		23x8.50-12	Yes	2	Traction
GT-7	4.80/4.00-8 -----	-----	No	4	Studded
		23x8.50-12	Yes	2	High-Flotation

\* Ply rating

## Hydraulic System Codes

John Deere 140 Tractors are available with two different hydraulic systems as follows:

**H-1 Tractors** have one single spool hydraulic control valve, offering simultaneous operation of equipment with one lever. These tractors cannot be modified for three-lever operation, but may be equipped with lock-out arms, additional circuits and couplers to increase their versatility.

**H-3 Tractors** have one 3-spool control valve. Three levers permit individual control of each of three separate circuits. For example, with H-3 Tractors, you can operate the 3-point hitch, raise and lower a front-mounted blade and angle the blade. Each operation is independent of the others and is controlled by a separate circuit and lever.

A center hydraulic rockshaft permits use of center-mounted equipment such as rotary mowers and center blades, independently of front or rear applications.

## Group 10

# SPECIFICATIONS

<b>ENGINE SPECIFICATIONS</b>	
Engine Model No. . . . .	K321AS
Manufacturer . . . . .	Kohler
Cylinders . . . . .	One
Cycle . . . . .	Four
Bore & Stroke . . . . .	3.50 x 3.25
Displacement . . . . .	31.27 cu. in.
Speeds (fast) No load . . . . .	3800 rpm
Speeds (idle) . . . . .	1500 rpm
Horsepower (Engine Manufacturer's Rating)* . . . . .	14 @ 3600 rpm
Normal Compression . . . . .	110-120 psi
Valve Clearance:	
(Intake) Cold . . . . .	0.010 in.
(Exhaust) Cold . . . . .	0.020 in.
Ignition . . . . .	Battery
Spark Plug Gap . . . . .	0.025 in.
Breaker Point Gap . . . . .	0.020 in.

\* The horsepower rating shown is established by the engine manufacturer in accordance with Standard Internal Combustion Engine Institute procedure. It is corrected to 60°F. and 29.92 in. Hg. Barometer and is developed from laboratory test engines equipped with standard air cleaner and muffler, less alternator equipment.

### CAPACITIES

Component	Quantity
Fuel Tank	1-3/4 U.S. Gallons
Crankcase	3 U.S. Pints*
Transmission	5 U.S. Quarts*

\* Initial capacity or after complete disassembly.  
 See page 20-3 of this section.

### TRACTOR SPECIFICATIONS



Item	140 Tractor with GT-3 Tires	140 Tractor with GT-4 Tires	140 Tractor with GT-5 Tires
<b>WHEEL TREAD</b>			
Front .....	31-1/4 in.	29-1/2 in.	31-1/4 in.
Rear .....	29 or 34-1/2 in.	29 or 34-1/2 in.	30-1/2 or 33 in.
<b>TIRE SIZES (Also see Group 5)*</b>			
Front .....	16x6.50-8 2 ply	4.80/4.00-8 4 ply	16x6.50-8 2 ply
Rear .....	23x8.50-12 2 ply	23x8.50-12 2 ply	23x10.50-12 2 ply
<b>TIRE INFLATION*</b>			
Front .....	6 to 16 psi	12 to 40 psi	6 to 16 psi
Rear .....	8 to 10 psi	8 to 10 psi	8 to 10 psi
<b>DIMENSIONS</b>			
Wheel Base .....	46 in.	46 in.	46 in.
Over-all Length .....	67-1/2 in.	67-1/2 in.	67-1/2 in.
Over-all Height .....	43 in.	43 in.	43 in.
Over-all Width:			
(min.) .....	38 in.	38 in.	40-1/2 in.
(max.) .....	42-1/2 in.	42-1/2 in.	43 in.
<b>CURB WEIGHT</b> .....	740 lbs.	740 lbs.	740 lbs.
<p>FUEL SYSTEM - See Section 30 for detailed specifications.</p> <p>ELECTRICAL SYSTEM - See Section 40 for detailed specifications.</p> <p>TRANSMISSION - See Section 50 for detailed specifications.</p> <p>DIFFERENTIAL - See Section 50 for detailed specifications.</p> <p>CLUTCH, ENGINE DISCONNECT OR NEUTRAL RETURN - See Section 50 for detailed specifications.</p> <p>BRAKES - See Section 50 for detailed specifications.</p> <p>STEERING AND WHEEL BEARINGS - See Section 70 for detailed specifications.</p>			

\* The GT-6 and GT-7 tire combinations are available as options.  
 They are as follows:

GT-6 ----- GT-3 Front High-Flotation Tires and GT-4 Traction Rear Tires.

GT-7 ----- GT-4 Front Tires and GT-5 High-Flotation Rear Tires.

### BOLT TORQUE CHART

Grade of Bolt		SAE-2	SAE-5	SAE-8	Socket or Wrench Size	
Min. Tensile Strength		64,000 PSI	105,000 PSI	150,000 PSI		
Grade Marking on Bolt						
U.S. Standard		TORQUE IN FOOT POUNDS			U.S. Regular	
Bolt Dia.	U.S. Dec. Equiv.				Bolt Head	Nut
1/4	.250	6	10	14	7/16	7/16
5/16	.3125	13	20	30	1/2	1/2
3/8	.375	23	35	50	9/16	9/16
7/16	.4375	35	55	80	5/8	11/16
1/2	.500	55	85	120	3/4	3/4
9/16	.5625	75	130	175	13/16	7/8
5/8	.625	105	170	240	15/16	15/16
3/4	.750	185	300	425	1-1/8	1-1/8
7/8	.875	* 160	445	685	1-5/16	1-5/16
1	1.000	250	670	1030	1-1/2	1-1/2

Multiply readings by 12 for inch pound values.

\* "B" Grade bolts larger than 3/4-inch are sometimes formed hot rather than cold which accounts for the lower recommended torque.

NOTE: Allow a tolerance of plus or minus 10% on all torques given in this chart.

### SET SCREW SEATING TORQUE CHART

Screw Size	Cup Point	Square Head
Torque in Inch Pounds		
#5	9	--
#6	9	--
#8	20	--
#10	33	--
1/4	87	212
5/16	165	420
3/8	290	830
7/16	430	--
1/2	620	2100
9/16	620	--
5/8	1225	4250
3/4	2125	7700

Divide readings by 12 for foot pound values

NOTE: Allow a tolerance of plus or minus 10% on all torques given in this chart.

**REAR WHEEL WEIGHT BOLT SIZE CHART**

Tire/Wheel Option	Wheel Position	No. of Weights	Bolt Size
GT-3*	Narrow	1	1/2 x 4-3/4
GT-3*	Narrow	2	1/2 x 7
GT-3	Wide	1	1/2 x 5-1/4
GT-3	Wide	2	1/2 x 7-1/2
GT-5	Narrow	1	1/2 x 5-3/4
GT-5	Narrow	2	1/2 x 8
GT-5	Wide	1	1/2 x 5-1/4
GT-5	Wide	2	1/2 x 7-1/2
Adjustable	Not Reversible	1	1/2 x 2-1/2
Adjustable	Not Reversible	2	1/2 x 4-3/4

\* Raised portion of wheel weight out.

## Group 15 Tune-up and Adjustment

**IMPORTANT:** Before attempting to tune-up the 140 Tractor engine, first determine if it is in a condition whereby performance can be restored by tune-up. Do this by making the preliminary engine tests below.

### PRELIMINARY ENGINE TESTING

Operation	Specification	Reference
Cylinder compression	110-120 psi (1000 rpm)	Section 20, Group 5
Crankcase vacuum	5-10 inches of water column	Section 20, Group 5
Battery hydrometer test	1.260-1.280 sp. gr. 100% charged at 80° F.	Section 40, Group 10

### MINOR TUNE-UP GUIDE

Operation	Specification	Reference
Change oil	Summer above 32° F.— SAE 30 (AM30730) Winter below 32° F.— SAE 5W-20 (AM30710)	Section 10, Group 20
Clean and regap spark plug	Clean electrodes Clean insulation Replace gasket Set gap at 0.025 in.	Section 40, Group 15
Remove air cleaner and clean by tapping lightly against flat surface	Check air cleaner condition Replace if necessary	Section 30, Group 15
Adjust carburetor	High speed mixture needle Idle mixture needle	Section 30, Group 10
Adjust governor speed	Speed (fast)— 3800 rpm no load; Speed (idle)— 1200-1700 rpm	Section 20, Group 15
Check and clean fuel tank and strainer	Regular gasoline only	Section 30, Group 20

### MAJOR TUNE-UP GUIDE

**IMPORTANT:** Major tune-up should include all items listed for "Minor Tune-Up" on page 15-1 in addition to the following:

Operation	Specification	Reference
Recondition carburetor	Install carburetor kit	Section 30, Group 10
Inspect and clean breather assembly	Replace parts as necessary. Install new gaskets. Check crankcase vacuum after assembly	Section 20, Group 10
Remove shrouding, clean engine and cylinder head fins	.....	Section 20, Group 10
Test condenser	See Manufacturer's Specifications	Section 40, Group 15
Test coil	See Manufacturer's Specifications	Section 40, Group 15
Replace breaker points	Point gap 0.020 in.	Section 40, Group 15
Retime ignition	"S" mark on flywheel at 1200-1800 rpm	Section 40, Group 15

### COMMON ADJUSTMENTS

*NOTE: The following common adjustments are recommended after engine tune-up is completed.*

Adjustment	Specification	Reference
Engine disconnect	.....	Section 50, Group 10
Steering linkage	.....	Section 70, Group 10
Brakes	.....	Section 50, Group 10
Speed control cam and linkage	.....	Section 50, Group 20

## Group 20 FUEL AND LUBRICANTS

### FUEL

Use regular grade gasoline of a recognized brand. Avoid using stale gasoline or gasoline that has been stored a long time. Stale gasoline does not vaporize properly and causes hard starting.

Premium grade gasoline (ethyl) is not recommended for small tractor engines. The engine compression ratio is not high enough to require premium grade, which can cause a buildup of lead deposits. These deposits cause a loss of power and shorten engine life.

Do not mix oil with gasoline. Do not use white gasoline.

### LUBRICANTS

Effective use of lubricating oils and greases is perhaps the most important step toward low upkeep cost, long tractor life and satisfactory service. Use only the lubricants specified in this group at the proper intervals.

We recommend John Deere Torq-Gard Supreme engine oil for use in the engine crankcase. Torq-Gard Supreme is compounded specifically for use in John Deere engines and provides superior lubrication under all conditions. NEVER PUT ADDITIVES IN THE CRANKCASE. Torq-Gard Supreme oil was formulated to provide all the protection your engine needs. Additives could reduce this protection rather than help it.

If oil other than Torq-Gard Supreme is used, it must conform to one of the following specifications:

#### SINGLE VISCOSITY OILS

API Service CD/SE, CD/SD, CC/SD or SD  
MIL-L-46152, MIL-L-2104C\*

#### MULTI-VISCOSITY OILS

API Service CC/SE, CC/SD or SD  
MIL-L-46152

\* As further assurance of quality, the oil should be identified as suitable for API Service Designation SD.

The charts below and on the next page indicate the lubricant, capacities and service intervals recommended for 140 Tractors beginning with Serial No. 30,001.

### CAPACITIES

Fuel Tank	1.75 U.S. Gallons
Crankcase	3.0 U.S. Pints*
Transmission/Rear Axle	5.0 U.S. Quarts*

\* Initial capacity or after complete disassembly. See page 20-3 of this section.

## TYPE OF LUBRICANT

### Crankcase

Depending on the expected prevailing temperature for the fill period, use the proper viscosity oil listed in the following chart.

Air Temperature	John Deere Torq-Gard Oil	Other Oils	
		Single Viscosity Oil	Multi-Viscosity Oil
Above 32°F.	SAE 30	SAE 30	Not Recommended
-10°F. to 32°F.	SAE 10W-20*	SAE 10W	SAE 10W-30*
Below -10°F.	SAE 5W-20* *	SAE 5W* *	SAE 5W-20* *

\* SAE 5W-20 oil can also be used to insure optimum lubrication at starting, particularly when engine is subjected to -10°F. or lower temperatures for several hours.

\*\* Some increase in oil consumption may be expected when SAE 5W-20 or SAE 5W oils are used. Check oil level more frequently.

Transmission/Rear Axle . . . John Deere All-Weather Hydrostatic Fluid or Automatic Transmission Fluid Type "F"  
 Tractor Grease Fittings and Front Wheel Bearings . . . . . John Deere Multipurpose Lubricant or SAE Multipurpose-Type Grease

## SERVICE INTERVALS

Crankcase (Oil Change)  
 Break-in . . . . . First 2 hours  
 Regular . . . . . Every 25 hours  
 Dusty Conditions . . . . . Every 8 hours  
 Transmission/Rear Axle  
 Oil Change and Filter . . . . . 500 hours or 2 years  
 Tractor Grease Fittings  
 (See page 10-20-4 for locations) . . Spring and Fall  
 Front Wheel Bearings (Repack) . . . . . 250 hours

### Air Cleaner

Clean (Normal Conditions) . . . . . 25 hours  
 Clean (Dusty Conditions) . . . . . 5 hours  
 Replace . . . . . 100 hours

## CHANGING CRANKCASE OIL

*NOTE: The best time to drain the crankcase is when the oil is hot. Dirt and foreign material in the crankcase is in suspension and is easier to drain out.*

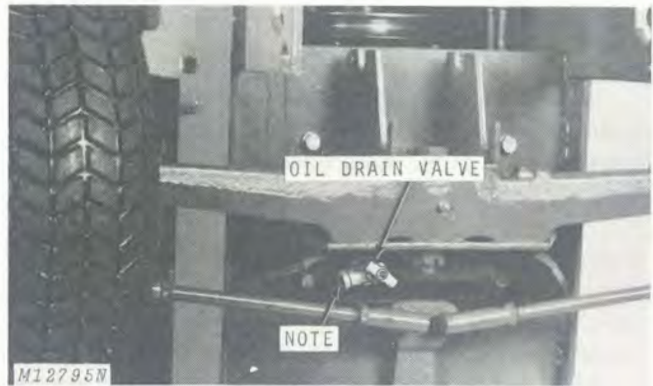

Fig. 1-Draining Crankcase (Serial No. 56,001- )

Open oil drain valve and allow oil to drain into a container, Figure 1.

*NOTE: For convenience a suitable length of 5/8-inch garden hose or plastic tubing may be installed on the drain valve to allow oil to be drained into a container away from the tractor.*

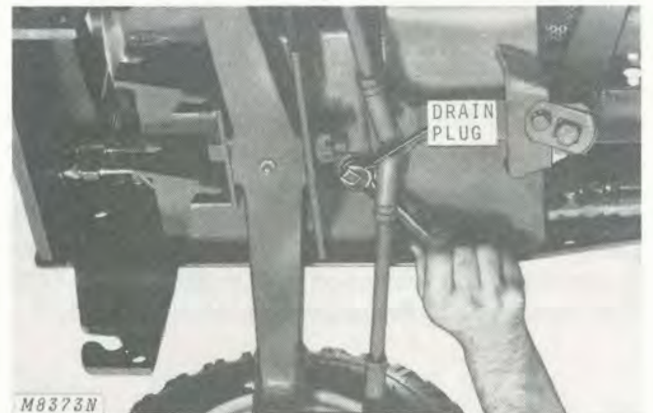

Fig. 2-Draining Crankcase (Serial No. 30,001-56,000)

Remove drain plug and allow oil to drain into container, Figure 2.

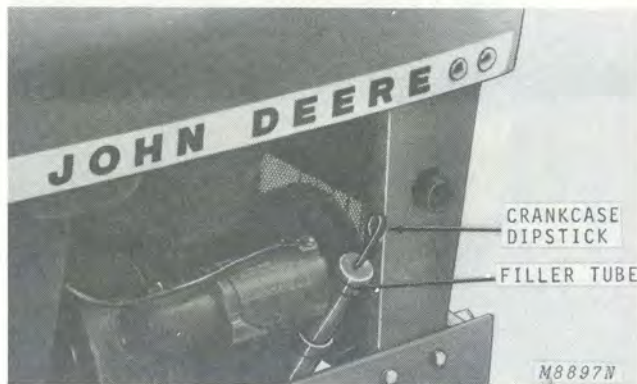

Fig. 3-Dipstick and Filler Tube

After the oil has drained, install drain plug and add 2-1/2 pints of the proper viscosity oil through filler tube, Figure 3. Check dipstick and add another half-pint if dipstick reading indicates necessity.

### CHANGING HYDROSTATIC DRIVE FILTER

**IMPORTANT:** Be extremely careful to prevent dirt or foreign material from entering the hydraulic system when changing filter. Clean dust and dirt from the edges of the filter before removing.

Unscrew and discard oil filter, Figure 4. If removal is difficult, a filter removal tool can be used.

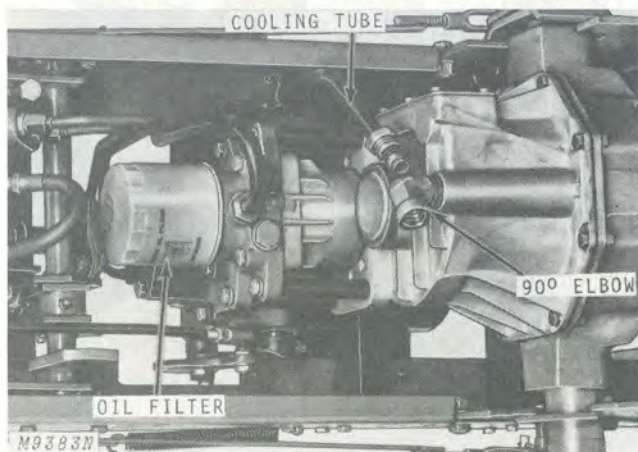

Fig. 4-Changing Transmission Oil Filter

Install a new John Deere oil filter. Moisten rubber gasket with transmission oil prior to installation. **IMPORTANT:** Tighten only hand tight.

### CHANGING HYDROSTATIC DRIVE OIL

To drain transmission drive oil, remove filter and disconnect cooling tube. Turn 90 degree elbow counter-clockwise until it points down, Figure 4. When drained, turn 90 degree elbow to original position and connect cooling tube. Install a new oil filter.

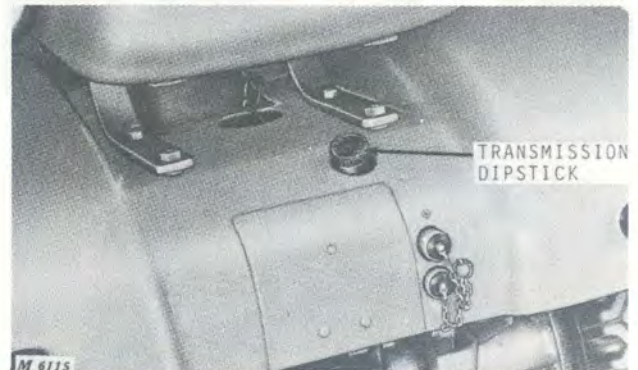

Fig. 5-Transmission Filler Tube and Dipstick

Add 3 quarts of oil. Check dipstick. Then add up to 2 additional quarts until level is to midpoint of "SAFE" range on dipstick, Figure 5. Use only John Deere All-Weather Hydrostatic Fluid or Automatic Transmission Fluid Type "F." Make final check with engine running and transmission control lever in neutral.

## GREASE FITTING LOCATIONS

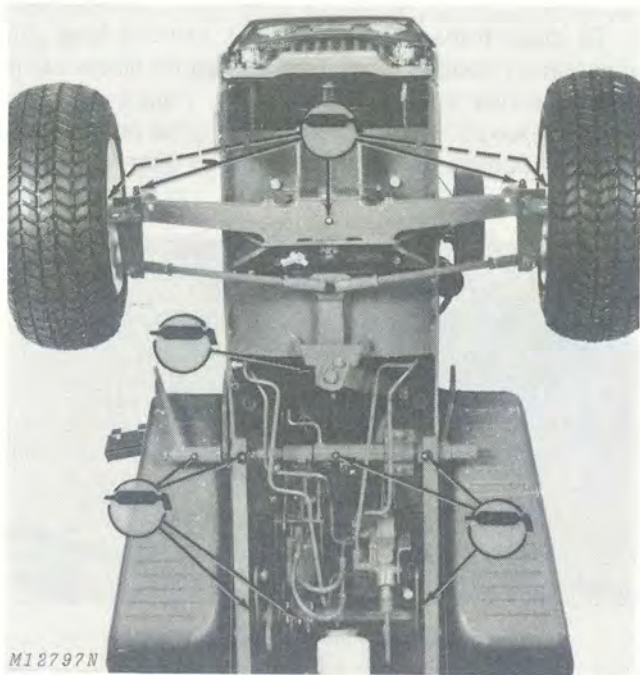

Fig. 6-Fittings on Front Axle, Steering Arm, Brake and Lift Linkage

Lubricate the grease fittings shown above, Figure 6, using a John Deere Pisto-Luber or hand grease gun containing John Deere Multipurpose Lubricant or an equivalent SAE multipurpose-type grease. Wipe fittings clean before and after lubrication.

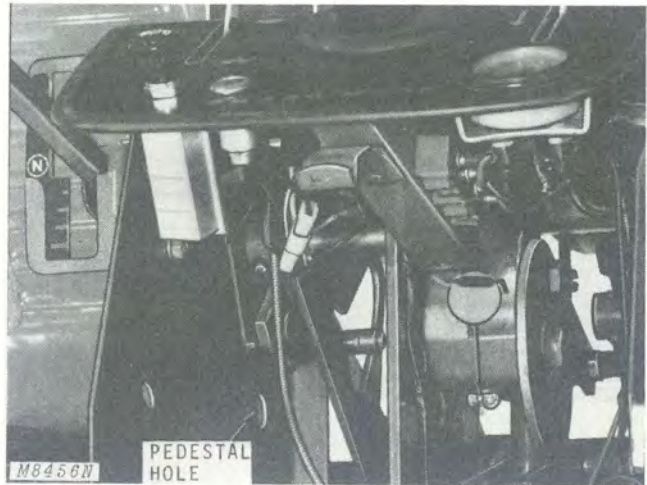

Fig. 7-Lubricating Steering Column

Insert grease gun through hole provided on right-hand side of pedestal, Figure 7, to lubricate steering column. Also lubricate grease fitting on hydraulic lever shaft, below.

**IMPORTANT: Do not overlubricate steering column fitting. Do not use a high-pressure grease gun on this fitting.**

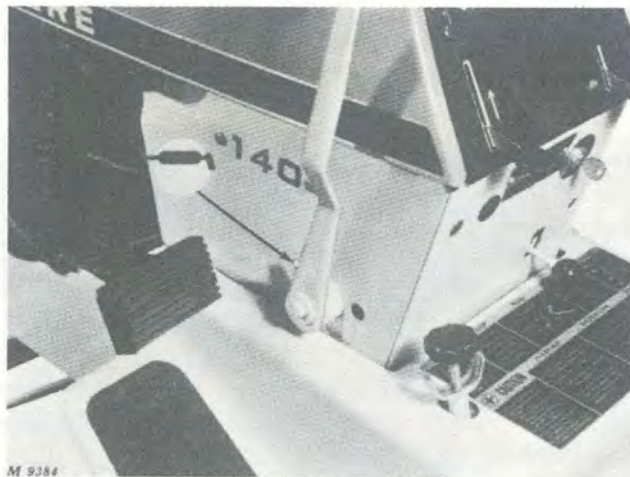

Fig. 8-Lubricating Hydraulic Lever Shaft

# Section 20 ENGINE

## Group 5 GENERAL INFORMATION

### TABLE OF CONTENTS

<b>GROUP 5 - GENERAL INFORMATION</b>		<b>GROUP 15 - PISTON, CRANKSHAFT, MAIN BEARINGS, BALANCE GEARS, AND FLYWHEEL</b>	
Description .....	5-3	General Information .....	15-1
Engine Analysis .....	5-4	Dynamic Engine Balancing System .....	15-2
Preliminary Engine Checks .....	5-4	Repair .....	15-3
Preliminary Engine Tests .....	5-5	Removing Engine .....	15-4
Diagnosing Malfunctions .....	5-7	Engine Service Support Stand .....	15-4
<b>GROUP 10 - CYLINDER HEAD, VALVES AND BREATHER</b>		Disassembling Engine .....	15-5
General Information .....	10-1	Removing Ring Gear .....	15-5
Valve Analysis .....	10-2	Removing Piston Rings .....	15-6
Repair .....	10-3	Piston Ring Analysis .....	15-6
Removing Valves .....	10-4	Inspecting Piston .....	15-8
Inspecting Cylinder Head .....	10-4	Piston Analysis .....	15-9
Inspecting Breather .....	10-5	Inspecting Crankshaft .....	15-11
Testing Valve Springs .....	10-5	Connecting Rod and Cap Analysis .....	15-11
Inspecting Valves .....	10-5	Inspecting and Repairing Block .....	15-12
Reconditioning or Replacing Valves .....	10-6	Deglazing Cylinder Bore .....	15-13
Replacing Valve Guides .....	10-7	Boring Cylinder Block .....	15-13
Replacing Valve Inserts .....	10-8	Inspecting Camshaft .....	15-13
Checking Valve Clearance .....	10-8	Inspecting Main Bearings .....	15-13
Installation .....	10-9	Bearing Analysis .....	15-13
Installing Valve Springs, Retainers and Keepers .....	10-9	Assembly .....	15-15
Assembling Breather .....	10-9	Replacing PTO End Main Bearing .....	15-15
Installing Cylinder Head .....	10-9	Replacing Balance Gear Stub Shafts .....	15-15
Installing Carburetor .....	10-10	Replacing Balance Gear Bearings .....	15-15
Checking Air Filter .....	10-10	Timing Balance Gears Without Special Tool .....	15-15
Spark Plug Gap .....	10-10	Timing Balance Gears With Special Tool .....	15-17
Breaker Point Gap .....	10-10	Assembling Bearing, Bearing Plate and Oil Seals .....	15-18
Specifications .....	10-11	Assembling Connecting Rod and Piston .....	15-18
Table of Clearances .....	10-11	Checking Piston Ring End Gap .....	15-19
Torque for Hardware .....	10-11	Installing Rings and Piston .....	15-19
Tune-Up Data .....	10-11	Attaching Rod to Crankshaft .....	15-20
Special Tools .....	10-12	Assembling Oil Pan on Block .....	15-20
		Assembling Ring Gear on Flywheel .....	15-20
		Installing Flywheel .....	15-21
		Assembling Shrouding .....	15-21
		Assembling Exterior Components .....	15-21
		Installation .....	15-22
		Installing Engine .....	15-22

*Continued on next page*

### TABLE OF CONTENTS - Continued

Adjustment .....	15-23	Installation .....	20-4
Throttle Linkage Adjustment .....	15-23	Installing Governor .....	20-4
Governor Speed Adjustment .....	15-23	Installing Camshaft .....	20-5
Specifications .....	15-24	Installing Governor Arm .....	20-5
Table of Clearances .....	15-24	Specifications .....	20-6
Torques for Hardware .....	15-24	Table of Clearances .....	20-6
Maintenance Data .....	15-24	Torque for Hardware .....	20-6
Special Tools .....	15-25	Special Tools .....	20-6
 GROUP 20 - CAMSHAFT, TAPPETS, AND GOVERNOR			
General Information .....	20-1		
Automatic Compression Release			
Camshaft .....	20-2		
Repair .....	20-3		
Removing Camshaft and Tappets .....	20-3		
Removing Governor .....	20-4		
Inspecting Camshaft .....	20-4		
Inspecting Governor Gear .....	20-4		

## DESCRIPTION

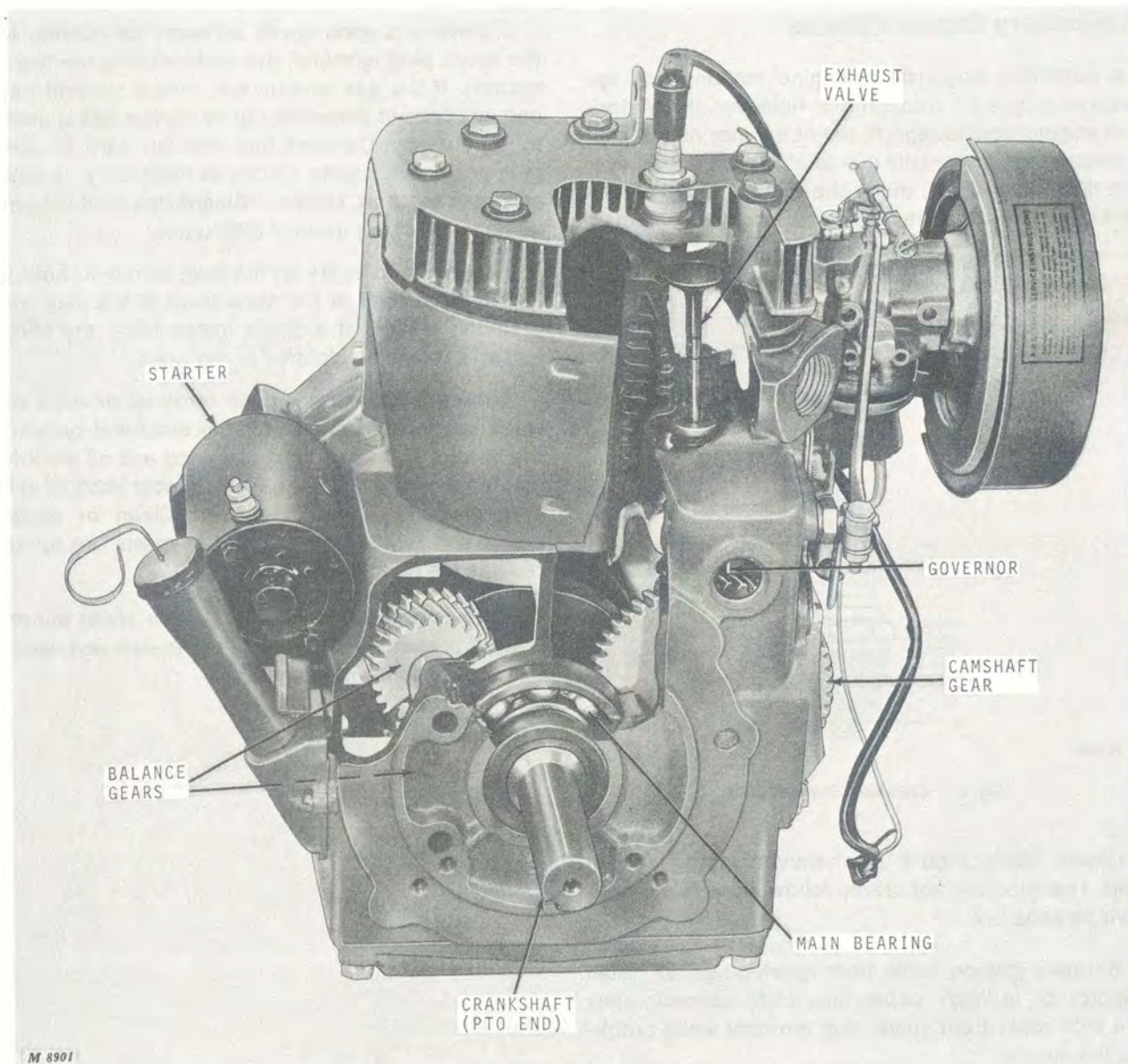

Fig. 1 - Cutaway View of Kohler K321AS Engine (PTO Shaft End)

140 Hydrostatic Tractors are equipped with a Kohler K321AS, four-cycle, L-head, single-cylinder internal-combustion engine. It has a cast-iron block with large bore - short stroke design.

The engine is air-cooled, has anti-friction ball bearings, oil bath lubrication and an internal flyweight governor.

Other features are a dynamic balancing system and battery ignition.

Detailed specifications are covered in Section 10, "General," and at the end of each group in this section.

## ENGINE ANALYSIS

### Preliminary Engine Checks

A complete diagnosis of engine malfunctions appears on pages 5-7 through 5-9. However, the majority of engine trouble reports are of a minor non-chronic nature and are usually due to electrical or fuel system difficulties. First, make the checks listed on the next page to isolate the majority of engine problems.



M 8502

Fig. 2 - Checking Spark at Plug

Check spark, Figure 2, whenever engine will not start. If engine will not crank, follow diagnosis procedure on page 5-7.

Remove ignition cable from spark plug and install adaptor or ordinary paper clip. Hold approximately 1/4 inch away from spark plug terminal while cranking the engine.

If there is a good spark between the adaptor and the spark plug terminal, the problem is in the fuel-air system. If the gas tank is full, check shut-off valve and gas lines to carburetor to be certain gas is getting to carburetor. Connect high-tension wire to spark plug and crank engine. Choke as necessary. If engine still does not start, refer to "Diagnosing Malfunctions" guide to check for internal difficulties.

If there is no spark at the plug terminal, hold the high-tension lead at the steel base of the plug while cranking engine. If a spark jumps here, the plug is bad and should be cleaned or replaced.

If there is no spark at the terminal or base or a weak spark, the trouble is in the electrical system. If the battery and spark plug are good and all electrical connections are tight, the trouble most likely is in the breaker points and condenser. Clean or replace points and adjust gap. If breaker points are burned, replace the condenser also.

If the engine still does not start, or starts but does not run properly, make the compression and vacuum tests on the following pages.

## Preliminary Engine Tests.

The following preliminary engine tests are recommended to detect and isolate possible malfunctions before proceeding with further diagnosis. These tests are especially important when the engine is burning oil, losing power or running erratically and when carburetion and ignition adjustments do not correct the condition.

### Compression Test

The 140 Tractor engine features an automatic compression release camshaft (ACR). Because ACR relieves compression pressure during slower cranking speeds (650 rpm and below), it is important to crank the engine at 1000 rpm or more to obtain an accurate test unless, however, the engine is cranked backward.

With the engine installed in the tractor, test compression as follows.

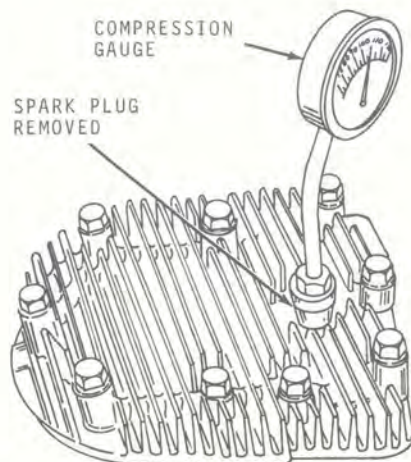

M 8503

Fig. 3 - Testing Engine Compression

Place hydrostatic control lever in neutral, depress brake pedals and set parking brake. Be sure oil in crankcase is at proper level.

*NOTE: Be sure tractor drives are all disengaged. Run engine until warm, then stop the engine.*

Remove spark plug. Also remove air filter for most accurate test.

Set throttle and choke valve in wide open position by raising throttle lever all the way and lowering choke lever.

Wind a 1/4-inch starter rope around flywheel sheave in the opposite direction of crankshaft rotation. Have a helper hold the compression gauge in the spark plug hole, Figure 3. Pull starter rope and record reading. Repeat procedure to insure correct reading.

### Test Conclusions

An engine in top operating condition will have a compression gauge reading of 110 to 120 psi.

A compression test reading above 120 psi indicates excessive deposits in the combustion chamber or on the piston.

A reading lower than 100 psi indicates leakage at the cylinder head gasket, piston rings or valves. *The engine should be repaired or reconditioned if compression falls below 100 psi.*

To determine whether the rings or the valves are at fault, pour about one tablespoonful of heavy oil into the spark plug hole. Crank the engine several revolutions to spread the oil and repeat the compression test.

The oil will temporarily seal leakage around the piston rings. If the same approximate compression reading is obtained, the rings are satisfactory, but the valves are leaking or the piston is damaged. If the compression has increased considerably over the original readings, there is leakage past the rings.

### Crankcase Vacuum Test

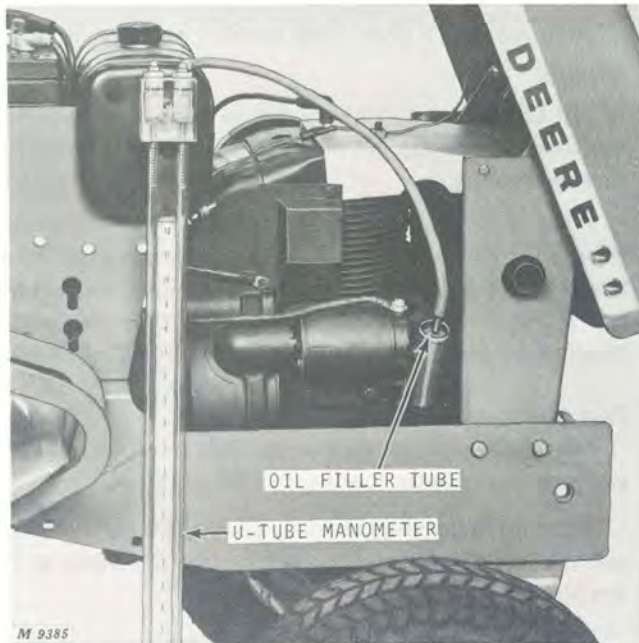

Fig. 4 - Checking Crankcase Vacuum

The crankcase breather maintains a partial vacuum in the crankcase when engine is operating properly.

To determine proper operation of the breather, connect a water U-tube manometer to the oil filler tube, Figure 4. The tester must hang vertically as shown. Start and run engine at 1200 to 1700 rpm. Allow engine to warm up and observe reading on scale. Follow manufacturer's recommendations for installation, testing and compensation for the effect of altitude on the gauge reading.

### Test Conclusions

Proper crankcase vacuum is a 5-inch to 10-inch water column.

A crankcase vacuum reading lower than indicated above is most likely due to a leaking breather valve or improperly assembled breather. See Group 10 and carefully reassemble all breather parts. A low vacuum reading may also be caused by leaky valves, engine blow-by, or worn oil seals.

If the crankcase is found to be pressurized rather than have a vacuum, chances are that the breather filter is plugged.

Engines with zero vacuum or pressurized crankcase will likely be pumping oil into the combustion chamber or out the breather or oil seals. This can be detected by watching for excessive exhaust smoke, engine overheating or oil leakage outside the engine.

## DIAGNOSING MALFUNCTIONS

### Engine

#### Engine Will Not Crank

- Hydrostatic control lever not in neutral.
- Battery discharged or defective.
- Neutral-start switch and bracket loose or not properly adjusted.
- PTO drive engaged.
- Defective safety switch (es).
- Defective starter.
- Defective solenoid.
- Loose electrical connections.
- Defective key switch
- Engine seized

#### Engine Cranks But Will Not Start

- Empty fuel tank.
- Restricted fuel tank vent.
- Fuel shut-off valve closed (valve below fuel tank).
- Clogged, restricted or air-locked fuel line.
- Breaker points worn or pitted.
- Spark plug fouled or pitted.
- Battery not fully charged.
- Loose electrical connections.
- Faulty condenser.
- Defective ignition coil.
- Dirt in fuel system.
- Frayed wire (s) causing ground (s).

#### Engine Starts Hard

- Spark plug pitted or fouled.
- Breaker points worn, pitted or out of adjustment.
- High-tension wire shorted.
- High-tension wire loose at spark plug or coil.
- Loose electrical connections.
- Restricted fuel tank vent.
- Clogged fuel line or air lock.
- Broken choke or throttle cable.
- Dirt or water in fuel system.
- High speed and idle mixture needles not properly adjusted.
- Wrong valve clearance.
- Head gasket leaking.
- Low compression.

#### Engine Starts But Fails to Keep Running

- Restricted fuel tank vent.
- High speed and idle mixture needles not properly adjusted.
- Broken choke cable.
- Dirt or water in fuel system.
- Carburetor float leaking or not properly adjusted.
- High-tension wire loose at spark plug or coil.
- High-tension wire shorted.
- Breaker points not properly adjusted.
- Loose connections.
- Defective head gasket.
- Faulty condenser.

## DIAGNOSING MALFUNCTIONS - Continued

### Engine Runs But Misses

- High-tension wire loose from spark plug or coil.
- Breaker points out of adjustment or worn and pitted.
- Spark plug fouled or pitted, incorrect gap.
- Loose electrical connections.
- Carburetor float leaking or not properly adjusted.
- Dirt or water in fuel system.
- Wrong valve clearance.
- Faulty coil.
- Engine shrouding plugged (overheats).

### Engine Misses Under Load

- Spark plug fouled or pitted, incorrect gap.
- High speed and idle mixture needles not properly adjusted.
- Incorrect spark plug.
- Breaker points out of adjustment or worn and pitted.
- Ignition out of time.
- Dirt or water in fuel system.
- Stale fuel.

### Engine Will Not Idle

- Idle speed too slow.
- Idle mixture needle not properly adjusted.
- Dirt or water in fuel system.
- Restricted fuel tank filler cap.
- Spark plug fouled or pitted, incorrect gap.
- Wrong valve clearance.
- Low engine compression.

### Engine Misses When Advancing Throttle

- Cold engine.
- High speed and idle mixture needles not properly adjusted.
- Spark plug fouled or pitted, incorrect gap.
- Linkage misaligned (throttle arm-to-governor).

### Engine Loses Power

- Crankcase low on oil.
- Engine shrouding plugged (overheats).
- Excessive engine load.
- Restricted air filter.
- Dirt or water in fuel system.
- High speed and idle mixture needle not properly adjusted.
- Spark plug fouled or pitted (incorrect gap).
- Too much oil in crankcase.
- Low engine compression.
- Worn cylinder bore.

### Engine Overheats

- Dirty or plugged shrouding and engine fins.
- High speed and idle mixture needles not properly adjusted.
- Too much oil in crankcase.
- Crankcase low on oil.
- Excessive engine load.

### Engine Knocks

- Engine out of time.
- Excessive engine load.
- Crankcase low on oil.

### Engine Backfires

- High speed and idle mixture needles not properly adjusted.
- Loose cylinder head or blown head gasket.
- Intake valve sticking in guide.
- Ignition out of time.

## DIAGNOSING MALFUNCTIONS—Continued

### Engine Uses Excessive Amount of Oil

- Clogged breather assembly.
- Breather not assembled properly.
- Worn or broken piston rings.
- Worn cylinder bore.
- Clogged oil holes in piston.
- Wrong size piston rings.
- Worn valve stems and/or valve guides.
- Incorrect oil viscosity.
- Faulty breather causing low crankcase vacuum.

### Engine Runs Erratically or Surges

- Dirt or water in fuel system.
- High speed and idle mixture needles not properly adjusted.
- Idle speed too slow.
- Spark plug fouled or pitted (incorrect gap).
- Poor compression.
- Faulty breather causing low crankcase vacuum.
- Carburetor leaking at gaskets or at connection.
- Restricted fuel tank vent.
- Throttle-to-governor linkage misassembled.
- Throttle-to-governor linkage improperly adjusted.
- Breaker points out of adjustment, worn or pitted.

### Gasoline in Crankcase

- Carburetor float not properly adjusted or leaking.
- Float valve and/or seat leaking.

### Excessive Vibration

- Engine balance gears timed wrong.
- Bolts holding engine to engine base are loose.
- Misalignment or excessive drive shaft wear.
- Loose PTO pulley.
- Loose or improperly balanced flywheel.
- Worn clutch coupling.
- Engine out of time.
- Loose flexible coupling between drive shaft and hydrostatic transmission.



## Group 10 CYLINDER HEAD, VALVES, AND BREATHER

### GENERAL INFORMATION

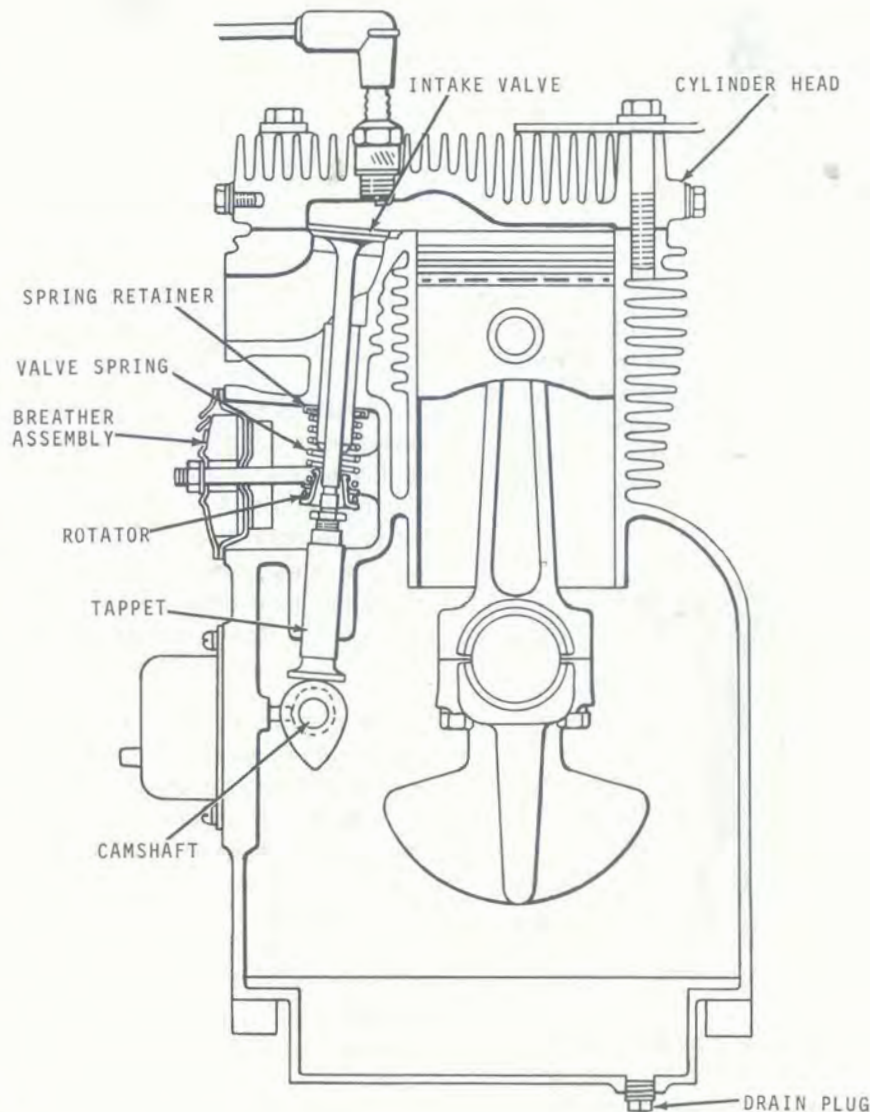

M 9386

Fig. 1-Schematic View of Intake Valve, Tappet, and Breather Assembly

It is not necessary to remove the engine from the tractor to grind valves and valve seats or to service the breather assembly.

The 140 Tractor has valve rotators on both the intake and exhaust valves (15, Figure 6). Both valves also feature replaceable inserts (29, 30, Figure 6) which are pressed into the block.

Valve guides can be replaced when wear tolerances are exceeded.

The breather assembly is mounted in front of the valve spring chamber below the carburetor.

## VALVE ANALYSIS



Fig. 2 - Lead Deposits on Leaky Intake Valve

Lead deposits on the intake valve consist mostly of lead and some metal which comes from the lubricating oil. It is caused by a small amount of leakage of exhaust gases back into the intake port area. This indicates that the valve is not seating properly. Grind the valve and reface the seat to correct this condition. **NOTE:** Be sure to correct valve-to-tappet clearance after grinding valves. See page 10-8.



Fig. 3 - Valve Stem Corrosion

Valve stem corrosion is caused by moisture finding its way into the engine. Moisture in the fuel-air mixture can condense inside the engine when engine is stopped before it has had a chance to warm up.

Valve corrosion can also occur during storage when the engine has not been run for some time. Fogging or pouring oil in the combustion chamber before storing will prevent valve corrosion.

Corroded and pitted valves tend to collect deposits which in turn causes valve sticking. Always replace badly corroded or pitted valves with new valves.



Fig. 4 - Exhaust Valve Running Too Hot

Exhaust valves are designed to function in temperatures exceeding 5000° F. However, when operating at this temperature for long periods of time, valve burning occurs. A tell-tale sign of valves running too hot is the dark discoloration of the valve stem down into the area protected by the valve guide. Another indication is disfiguration of the valve margin and valve face. Valve inserts may also begin to burn away.

The most common cause of an overheated engine and valves is poor cooling due to dirt or obstructions inside the intake shrouding. Remove and clean shrouding and all cooling fins on the engine if this condition is noticed. **NOTE:** Never run engine with shrouding removed.

Also check for improper valve timing by checking and correcting valve clearance.

Worn valve guides or valve springs can also cause overheated valves.

Valves running hot also can be caused by a lean fuel mixture, improper spark plug or over-heated spark plugs which cause pre-ignition.



Fig. 5 - Gummy Valve Causing Valve to Stick

Using gasoline which has been left in the tank a long time is a common cause of sticking valves.

Sometimes this gummy substance can be seen on the valve. When this condition is found, it is also likely that the carburetor also contains gum deposits and will require a complete cleaning.

Advise customer always to use fresh gasoline and always to drain gas from all fuel lines and carburetor before storing tractor.

## REPAIR

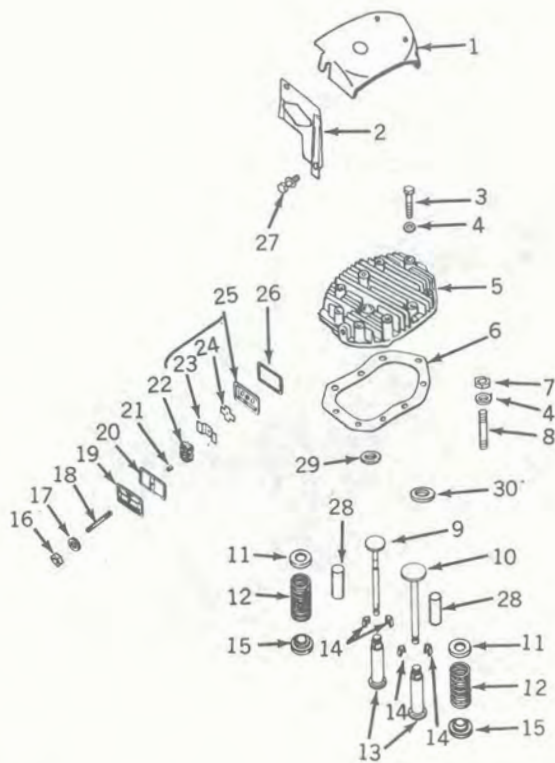

- 1 - Head Baffle
- 2 - Side Baffle
- 3 - Cap Screw (8 used)
- 4 - Washer (9 used)
- 5 - Cylinder Head
- 6 - Head Gasket
- 7 - Hex. Nut
- 8 - Stud
- 9 - Exhaust Valve
- 10 - Intake Valve
- 11 - Upper Spring Retainer (2 used)
- 12 - Valve Spring, Intake and Exhaust (2 used)
- 13 - Tappet (2 used)
- 14 - Spring Keeper (4 used)
- 15 - Rotator, Intake and Exhaust (2 used)
- 16 - Hex. Nut
- 17 - Lock Washer
- 18 - Stud
- 19 - Cover
- 20 - Outer Gasket
- 21 - Seal
- 22 - Filter
- 23 - Baffle
- 24 - Reed
- 25 - Breather Plate Assembly
- 26 - Inner Gasket
- 27 - Cap Screw (4 used)
- 28 - Valve Guides (2 used)
- 29 - Exhaust Valve Insert
- 30 - Intake Valve Insert

M 9387

Fig. 6 - Exploded View of Cylinder Head, Valves and Breather

## REPAIR - Continued

It is not necessary to remove the engine from the tractor when servicing the cylinder head, head gasket, muffler, breather assembly, valves and valve seats.

Disconnect choke conduit and cable at carburetor. Remove carburetor, breather assembly, head baffle, cylinder head and head gasket.

### Removing Valves

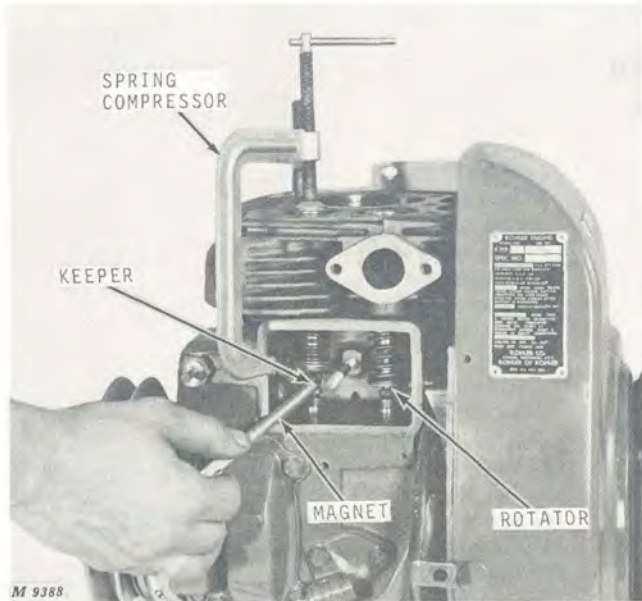

Fig. 7 - Removing Valves

Use a valve spring compressor to compress valve springs, Figure 7. Remove keepers from valve stem and lift valves from engine block.

Remove valve spring retainers, rotators, and valve springs from valve chamber.

### Inspecting Cylinder Head

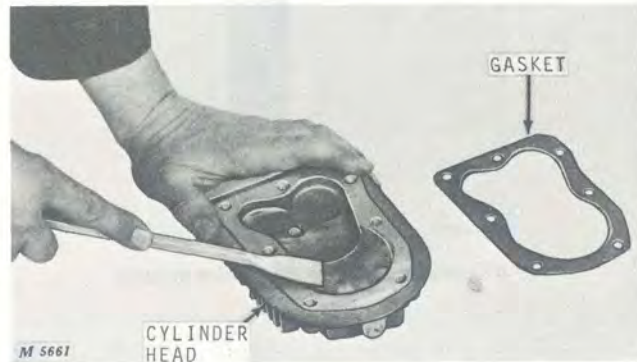

Fig. 8 - Cleaning Cylinder Head

Remove all deposits from combustion chamber and gasket surface of head with a scraper and a wire brush, Figure 8.

Be careful not to damage the cylinder head gasket surface. Use a safe cleaning solvent to remove dirt, grease and other deposits.



Fig. 9 - Checking Surface of Cylinder Head

Check the cylinder head for cracks and broken cooling fins and inspect the gasket surface for burrs and nicks. Replace the head if any of these conditions are found.

When a cylinder head is removed because of gasket leaks, check the flatness of the cylinder head by placing it on a surface plate, Figure 9. Check to see that gasket surfaces make contact at all points. Replace the cylinder head if it is warped.

**NOTE:** Always use new head gasket after removing cylinder head.

### Inspecting Breather

Clean all breather parts in solvent. Blow out filter contamination with compressed air or replace with new filter as necessary.

Inspect reed valve to be certain it is flat and not damaged.

Be sure small drain hole in breather plate is not clogged. Refer to Figure 24 when reassembling breather.

### Testing Valve Springs

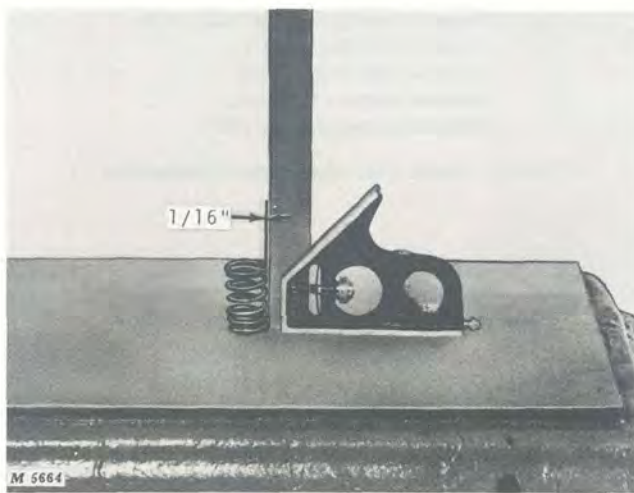

Fig. 10 - Valve Spring Squareness

Check valve spring for squareness, using a steel square and a surface plate, Figure 10. Stand the spring and square on end on the surface plate. Slide the spring up to the square. Revolve the spring slowly and observe the space between the top coil of the spring and the square. See "Specifications," page 10-11, for out-of-square limits.



Fig. 11 - Valve Spring Tension

Check valve spring for proper pressure, Figure 11. Refer to "Specifications," page 10-11, for free length of the spring and the pressure in pounds that the spring should exert when it is compressed to a measured length.

### Inspecting Valves

Remove carbon from valve head, face, and stem with a power-operated wire brush. Be sure carbon is removed and not merely burnished. Any carbon left on the stem will affect accurate alignment in the valve refacer collet.

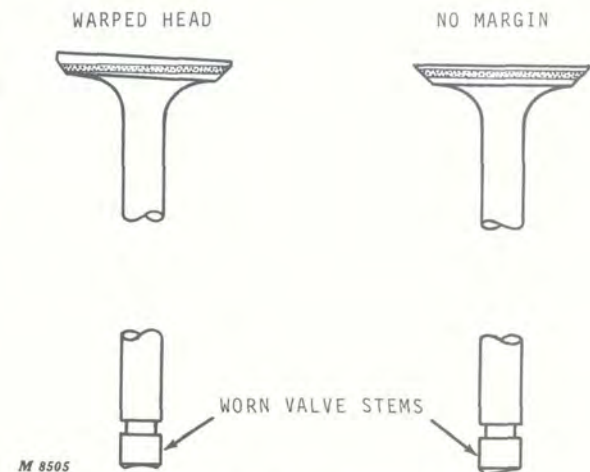

Fig. 12 - Faulty Valves

Check valve faces, heads and stems, Figure 12, for defects. Also look for bent valve stems and excessive corrosion causing pits on valve face or stem. Replace valves with warped head. Recondition or replace valves with less than 1/32-inch margin. Valve stem ends should be ground square before checking valve tappet clearance.